

Thermodynamics and Thermochemistry for Engineers

Stanley M. Howard, PhD
South Dakota School of Mines and Technology
Department of Materials and Metallurgical Engineering
Rapid City, SD 57701
USA

Preface

There are four reasons to write another textbook on thermodynamics for students involved with materials.

First is to add a richer historical context for the subject than is normally found in texts. Often students think thermodynamics is a collection of formulas to be memorized devoid of practical meaning when, in fact, the subject is rich in practical historical significance. Thermodynamics is a beautiful subject with a rich history of clever people who often had only practical reasons for their work. However, as it turned out, they along with theoreticians, provided tremendous insight into the fundamentals of what we now call thermodynamics. Even though the author has taught the subject nearly 50 times in the last 40 years, he is still finding new and fascinating insights into the historical underpinnings of the subject. This text attempts to keep these connections with the subject so that the student gains a richness that carries more meaning than just a rigorous treatment so commonly found in texts. The adding of historical context is not meant to denigrate the pure formal treatment of the subject. Indeed, that has its own appeal and place but more so for those first initiated in thermodynamics.

Second is to reduce the cost of the textbook for the student. This is accomplished by making this a digital text, which is also available in hard copy through TMS for a modest charge. Reduced pricing for Material Advantage members promotes student membership in the student chapters.

Third is convenience. Many universities require laptop computers and nearly every student has one. So, it makes sense that a digital text is paired with the laptop. Special pricing is possible when universities preload software resources on laptops. Digital form also permits students to print selected chapters to carry to the classroom thereby reducing the load they need to carry from class to class. Also, digital form obviates the undesirable ritual of selling textbooks at semester's end.

Fourth is purely one of author preference. When one writes a text, it is exactly as the author prefers. Chances are small that the author's preferences match another professor's, but it is certainly *perfect* for the author. The good news is, however, that since the text is in digital form, arrangements can be made to rearrange and add content including changing notation with the *replace* command. This alludes to an eventual open source textbook, which is inherently uncontrollable, but this is as it should be with a subject so beautifully and powerfully fundamental.

The author acknowledges considerable influence from three thermodynamic texts that have played a significant role in his learning of the subject: *Principles of Chemical Equilibrium* by Kenneth Denbigh and *Chemical Thermodynamics* by Irving M. Klotz. As a young professor the author used for a few years *Physical Chemistry for Metallurgists* by J. Mackowiak and employed some ideas from Mackowiak in describing the First Law. For several decades before the writing of this text, the author relied on David Gaskell's *Introduction to Thermodynamics for Materials Engineers*, 5th edition and the preceding editions.

Chapter 0

Basic Concepts

- **The Zeroth Law of Thermodynamics**
- **Definitions**
- **Mathematical Requirements**

The Zeroth Law of Thermodynamics was an afterthought occurring after the First, Second, and Third Laws of Thermodynamics were stated. It acknowledges that thermal equilibrium occurs between bodies of the same degree of hotness, which in today's vernacular is equivalent to temperature. Before heat was known to be a form of energy and thought to be a caloric fluid that was somewhat mystically related to objects, the concept of thermal equilibrium involved more than degree of hotness or temperature. For example, when small metal chips were made during the boring of canons, *Caloric Fluid Theory* held that the metal chips were hot because the 'fluid' flowed into the smaller pieces. In view of the complex and long-abandoned caloric theory, the Zeroth Law observation that *only degree of hotness fixes thermal equilibrium* is elegant in its simplicity and usefulness.

The Zeroth Law of Thermodynamics

The Zeroth Law of Thermodynamics states that if two bodies, a and b, are each in thermal equilibrium with a third body, c, then they are in thermal equilibrium with each other and that the only germane property the bodies have in common is the *degree of hotness*. This is a simple Euclidean relationship is expressed as follows where the function h is the measure of hotness.

If

$$h(a) = h(c) \text{ and } h(b) = h(c) \quad (0.1)$$

then

$$h(a) = h(b). \quad (0.2)$$

Hotness and temperature are so intertwined in today's language that the terms are used interchangeably; one immediately thinks bodies with the same hotness are also at the same temperature. This is true but temperature is a defined measure - not an observed natural property. Indeed, there was a time that temperature was unused, undefined and unknown, but thermal equilibrium could still be defined through observable hotness. Temperature scales have been defined in many different ways, including the first Fahrenheit scale that assigned zero to body temperature and 100 to a salt-ice-water eutectic mixture. This was later reversed so that 100 F was body temperature (actually 98.6 F) and salt-ice-water eutectic was 0 F (actually -6.0 F). This flexibility in the definition of temperature scales illustrates that as temperature scales were being established there was no inherent relationship between hotness and temperature. The laws of thermodynamics arise from observations of nature; consequently, the Zeroth Law does not rely on a defined temperature scale but only observable *hotness*. The *Absolute Thermodynamic Temperature Scale* is defined in Chapter 2.

Definitions

Other defined concepts that will be needed throughout this text are for *systems* and *variables*. A system is defined as a part of the universe selected for consideration. Everything that has any interaction with the system is termed the surroundings. Systems may be *open*, *closed*, or *isolated*. Open systems can exchange both mass and energy with the surroundings; closed systems exchange energy but no mass; isolated systems exchange neither mass nor energy. A variable describing a particular piece of matter is said to be *extensive* if its value depends on the quantity of the matter being described. For example, total heat capacity and mass are both extensive variables as opposed to *intensive* variables such as density, specific heat capacity, and temperature, which are intrinsic to the matter and independent of quantity. When Gibb's Phase rule is presented later in the text, it will be shown that fixing any two intensive variables for a pure material will fix all other intensive variables.

Throughout this text the terms variables and functions are often used interchangeably. A very important and mutually exclusive distinction is made between *path* and *state* functions. A function is said to be a state function if the change in the function while going from state *a* to state *b* is the same regardless of the path taken to move from state *a* to state *b*. The change in a path function does depend on the path taken. Illustrations of path functions will be given in Chapter, 1 but suffice it to say here that most variables - but not all - are state functions, including variables such as temperature, pressure, and volume. State functions are *exact* in the mathematical sense, which is to say that they may be differentiated in any order and the same result is obtained.

A process is said to be *reversible* while going from state *a* to state *b* if it could be returned to state *a* while leaving no more than a vanishingly small change in the surroundings. There is no requirement that the system actually returns to the original state, only that it could while leaving no more than a vanishingly small change in the surroundings. An *irreversible* process is one that requires some significant change in the surroundings were the system to be returned to its original state. This is illustrated by considering a compressed gas in a steel gas cylinder fitted with a frictionless piston. If the valve on the tank is opened so that the compressed gas (state *a*) inflates a balloon (state *b*), there is no way to return the gas to its original state without employing some substantial work to force it back into the high-pressure state inside the tank. Figure 1 shows in theory a way to reversibly take a compressed gas to a low-pressure. As the gas expands it lifts sand which is continuously moved to an infinite array of shelves. As the gas expands, the sand is lifted and deposited on the shelves. The accompanying gas expansion is reversible, because the gas can be returned to its original state by moving the sand stored on the shelves back onto the plate originally holding the sand. Perhaps one additional grain of sand might need to be lifted at the top of the expansion to commence the compression. This one extra grain falling from the top to the bottom of the stroke could be said to be a *vanishingly small change* in the surroundings; therefore, the expansion process is said to be reversible. It is noteworthy that a gas compression process is inherently reversible because the work of compressing the gas is always available to return the surroundings to their original state. Also, friction necessarily causes a process to be irreversible, because there is no way to reclaim the energy lost to friction for use for returning a system to its original state.

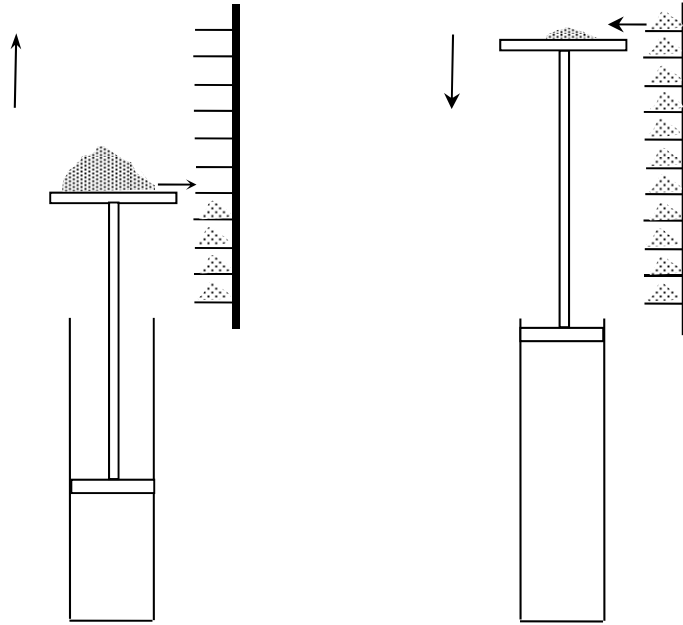

Figure 0.1 Reversible gas expansion process

Required Mathematical Tools

Mathematical tools from calculus required for the successful completion of this text are

Differentiation and Integration of rudimentary functions

Differentiation by the quotient rule and the product rule

Integration by parts

Total differentiation

Properties of partial derivatives,

Numerical integration using the trapezoid rule

L'Hopital's Rule

Chapter 1

The First Law of Thermodynamics – Conservation of Energy

The word *thermodynamics* is from the Greek *therme* (heat) and *dynamis* (power). It was coined by Joule¹ in 1849 to describe the evolving use and understanding of the conversion of heat to produce mechanical power in steam engines. These engines drove the rapid industrial expansion of the industrial revolution. Characterized by a renewed spirit of inquiry and discovery in a political environment supporting such inquiry, the industrial revolution required power beyond that available from manual labor, farm animals, water wheels, and wind mills. Near the end of the 17th century, inventions by Papin, and Savery pointed a way to use steam's expansion and condensation to perform useful work. In 1712 the marginally useful steam digester (Papin) and the water pump (Savery) were superseded by Thomas Newcomen's atmospheric engine that removed water from mines. Newcomen's engine was the first useful engine that produced work from heat.

http://en.wikipedia.org/wiki/Steam_engine

Practical advances in the steam engine increasingly drove the industrial revolution. Industry was being freed from the need for water wheels for industrial motive power. Industry could locate where ever there was a source of fuel. James Watt and Matthew Boulton in the late 18th century successfully marketed an improved efficiency steam engine by sharing the energy savings of their engines with their customers. Paralleling early advances in the practical advances in the steam engine was an ill-defined theoretical understanding of heat, work, and the maximum work attainable from heat that begged for definition. Clarity had to wait for several underlying principles: the true nature of heat as a form of energy, the Ideal Gas Law, and the absolute temperature scale.

Great effort was directed on producing the most work for the least heat since fuel was an expensive and limited resource. Many dubious theories were advanced: some claiming there was no theoretical limit on how much work could be extracted from heat – only practical limits. The quest for defining efficiency was finally realized, in the theoretical sense, by the work of Sadi Carnot in 1824 when he published and distributed in his ideas in an obscure booklet entitled *Reflections on the Motive Power of Fire*. This booklet was discovered by Clausius by chance at a news stand that stocked one of the few copies of Carnot's work. In the decades after his work became widely known, Carnot's ideas formed the basis of work by others including Clausius and Clapeyron. Carnot's accomplishment is remarkable because he did not have the advantage of the Ideal Gas Law advanced by Émile Clapeyron in 1834 or an absolute temperature scale defined by Lord Kelvin in 1848. Carnot was educated in Paris at the École Polytechnique. He was a military engineer but after Napoleon's defeat in 1815, Carnot left military service and devoted himself to his publication (in England?). Carnot was a contemporary of Fourier of heat transfer fame, who held a chair at the École Polytechnique.

¹ Perrot, Pierre (1998). *A to Z of Thermodynamics*. Oxford University Press. [ISBN 0-19-856552-6](#). [OCLC 123283342 38073404](#)

Carnot's short life (1796-1834) coincided with the period during which the Caloric Fluid Theory of heat was being debunked. In 1798 Count Rumfordⁱ proposed that heat was not a fluid but rather a form of energy. Although Carnot lived in the world of controversy on these competing views of heat, the controversy, which ended with Joule's work in 1840, it did not prevent Carnot's progress. Today, we accept heat to be a form of energy, not a caloric fluid, and it seems likely Carnot knew this as well. However, his thinking about steam engine efficiency was illustrated in fluid terms. He thought of heat as water driving a water wheel to produce work. The heat's temperature driving a steam engine was analogous to the water's height. The farther the water fell over the water wheel, the greater the work produced; the farther the temperature used to power a steam engine dropped, the greater the work produced.

Today's student arrives in the classroom with a better understanding of heat and work than the pioneers who built steam engines had. Trailing the builders by about a century, theoreticians eventually defined the theoretical limitations of the conversion of heat into work. Steam engines were followed by the internal combustion engine and the turbine engine. All convert the heat from fuel combustion into work and are now generalized as heat engines. They all have the same theoretical limitations described by the early thermodynamicists. The work of these early thermodynamicists is important for every engineer to know. Even more important for the materials and metallurgical engineer is that the analysis of heat engines leads to an understanding of entropy, the basis of predicting if a process is possible. Entropy is the arrow of time, but before it can be presented one must understand heat engines.

First Law of Thermodynamics

The First Law of Thermodynamics may be stated as follows:

In an isolated system of constant mass, energy may be distributed in different forms but the total energy is constant.

The term *system* means a region of space under consideration.

The term *isolated* means that no mass or energy is allowed to enter or leave the system.

The term *constant mass* precludes the occurrence of nuclear processes.

Figure 1.1 shows some of the many forms of energy. The First Law is a statement of conservation of energy. The analysis of heat engines involves only three of the many forms of energy shown in Figure 1.1: internal energy, heat, and work. The inclusion of heat (q) and work (w) are understandable since they are the forms of energy under consideration in heat engines. The internal energy, U , is needed to account for the change of the working fluid's (steam) energy. The internal energy is the total energy of all the molecular motion, bonding energy, etcetera, within the working fluid. The working fluid's internal energy changes as the working fluid's temperature is changed by the addition or removal of heat. Therefore, the change in the working fluid's internal energy is related to the amount of heat exchanged with the working fluid and the work performed by the working fluid. The First Law may be written

- i. Born Benjamin Thompson in Woburn, Massachusetts in 1753. Left with the British in 1776 as a Loyalist. The Bavarian government bestowed the title *Count of the Holy Roman Empire*

$$\Delta U = q - w \tag{1.1}$$

The signs on the q and w terms are completely arbitrary, but once assigned, a sign convention is established. If heat is added to the working fluid, it will raise the working fluid's internal energy. Therefore, positive q is heat *into* the system. Likewise, since a system that performs work, will decrease the internal energy, positive w is work done *by* the system. One could change any sign in Equation (1.1) and it would simply change the sign convention.

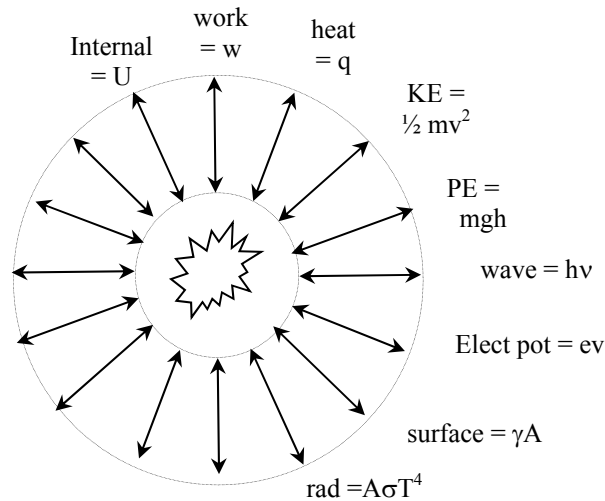

Figure 1.1 Conservation of Energy Forms

Throughout this text the sign convention set by Eq. (1.1x) will be used. Forms of energy other than heat, work, and internal energy are excluded from consideration in the First Law; however, when a system is encountered in which another form of energy is important, such as surface energy (surface tension) in nanoscience, the First Law can easily be amended. When kinetic energy, potential energy, and friction are included, the resulting equation is called the Overall Energy Balance used in the analysis of fluids in piping systems. Such amendments are beyond the scope of this text.

The focus of this chapter is the use of the First Law to analyze the behavior of gases undergoing selected processes so as to lay the foundation for understanding entropy – the arrow of time. Entropy change is the basis for predicting by computation if a processes is at equilibrium or, if not, the direction of spontaneous change. The typical processes selected for consideration are isothermal (constant temperature), isobaric (constant pressure), isochoric (constant volume), adiabatic (no heat exchange). Before such processes are considered, a review of ideal gases properties and definition of heat capacity is needed.

Ideal Gas

An ideal gas has the following properties:

- Small atoms that have volumes that are negligible compared to the volume of the container enclosing the gas
- Atoms that store energy by translation motion only ($\frac{1}{2} mv^2$), which excludes rotational, vibrational, and bond energies associated with molecules.
- Atoms that have perfectly elastic collisions with each other and with the container walls
- Atoms have no bonding interactions
- Atoms are randomly distributed within the container holding them

Ideal gases observe the Ideal Gas Law

$$PV = nRT \quad (1.2)$$

where P = pressure
V = volume
n = moles of gas
R = the gas constant
T = absolute temperature.

Energy added to an ideal gas can only be stored as kinetic energy. This energy is the internal energy of an ideal gas. As the energy of the gas increases, the velocity of the atoms increase. The internal energy is independent of the volume and, therefore, the pressure of the gas. It is a function of temperature only. A direct relationship between the internal energy of an ideal gas and temperature may be obtained from the properties of an ideal gas by considering an ideal gas with n atoms of gas having speed of c. The mass of one atom is m. If the atom with mass m moves inside a cube with edge of length L with velocity components v_x , v_y , and v_z , the force exerted by the atom in each direction is found from the rate of momentum change

$$F_x = \frac{2mv_x^2}{L}, F_y = \frac{2mv_y^2}{L}, F_z = \frac{2mv_z^2}{L} \quad (1.3)$$

The gas pressure is the sum of all these forces for all atoms divided by the cube's area of $6L^2$

$$P = \frac{2nmc^2}{6L^3} = \frac{2KE}{3V} \quad (1.4)$$

where the sum of the squares of the velocity components has been replaced by the atom speed squared, L^3 with volume, and nmc^2 with twice the total kinetic energy of the gas. This kinetic energy is also the internal energy of the ideal gas, which for one mole of gas gives

$$PV = \frac{2}{3}U = nRT \quad (1.5)$$

Work

It takes work to compress a gas. This work may be determined by integrating the definition of work

$$w \equiv \int_1^2 \mathbf{F} \cdot d\mathbf{s} \quad (1.6)$$

The force, F , is the product of the pressure P of the gas being compressed and the area A of the piston compressing the gas as shown in Figure 1-2. The change in piston distance is related to the gas's volume change as shown. Substituting these expressions for F and ds in Equation (1.6) gives

$$w_c \equiv \int_1^2 P dV \quad (1.7)$$

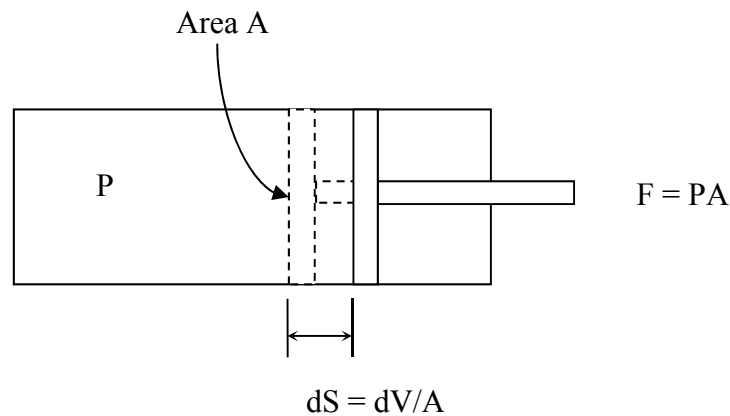

Figure 1.2 Relationship between pressure and force and piston distance and volume change during gas compression

If a gas undergoes expansion, the computation of work requires information about the restraining force in Equation (1.6). For example, it is possible to expand a gas without any restraining force. This is called *free expansion* and such expansion performs no work. Free expansion is rarely achieved since it requires that there is no atmospheric pressure, which requires work to displace. The opposite extreme to free expansion is *reversible* expansion. Under this condition, the restraining force is only infinitesimally less than the maximum force exerted by the gas; namely, PA . The reversible work is the maximum work that a gas can perform on expansion. Therefore the work exerted on expansion can range from maximum or reversible work all the way to the zero work of free expansion.

$$w_E \leq \int_1^2 PdV \quad \begin{array}{l} \text{Irrev} \\ \text{Rev} \end{array} \quad (1.8)$$

No such range in work is needed for compression since the maximum work must always be performed on compression. For convenience and simplicity of writing equations, work will not be subscripted as either compression or expansion type work. Work will always be written as though it is maximum work and the student should must always exercise care when using the maximum work expression and make the required downward adjustments for expansion occurring under irreversible conditions. Of course, the same care must be used in computing heat during expansion since it is also a path function changing in concert with work to equal ΔU .

Equation (1.6) shows that the area under a plot of P versus V equals the work of compressing a gas as shown in Figure 1-3. If the compression proceeds along the path labeled *a*, the work required to compress the gas equals the cross-hatched area in accordance with Equation (1.6). The work done on the gas during compression is negative in agreement with the sign convention of the First Law. The sign is also fixed by the decrease in volume, which makes the change in volume negative: a good reason for First Law sign convention. This negative value for work is denoted in the figure with negatively sloped cross hatching. This convention will be observed throughout this text.

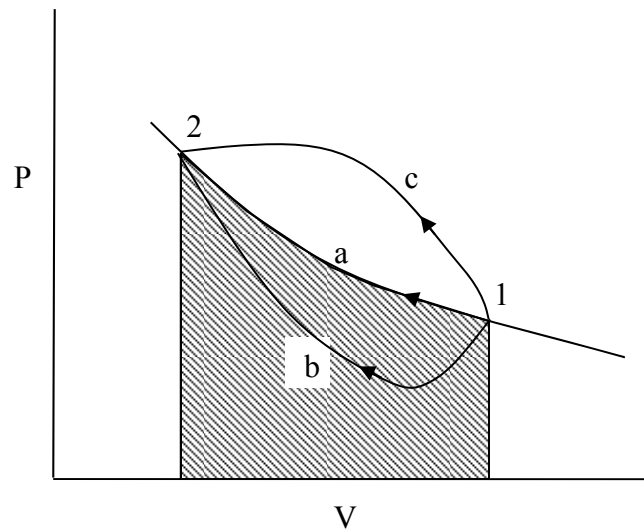

Figure 1-3 Work during gas compression.

If the compression proceeds from state 1 to state 2 along path *b*, the work as represented by the area under the P-V curve would be less than along path *a*: proceeding along path *c* would require more work than along path *a*. Since the value of work depends on the path taken from state 1 to state 2, work is a *path function* as described in Chapter 0. This also has implications for heat because heat and work both appear in the First Law. Internal energy, which equals the difference in heat and work according to the First Law, depends only on the state of the system. Indeed, in the case of an ideal gas, the internal energy is a function of

temperature only. The only way for the quality of the First Law to be maintained is for heat to change in concert with the work function of work so that their difference always equals the change in internal energy, a state function. This means that both work and heat are path functions.

Enthalpy

Enthalpy is term defined for convenience as

$$H \equiv U + PV \quad (1.9)$$

Since all terms in the definition are state functions, enthalpy is also a state function. The reason enthalpy is convenient is that it is equals to the heat for a reversible isobaric process providing the only work performed is expansion type work (PdV). Friction is an example of possible other types of work. Isobaric processes are common since work occurring under atmospheric conditions is essentially isobaric. The derivation of this useful relationship begins by writing the definition in differential form

$$dH = dU + PdV. \quad (1.10)$$

Substitution of the incremental form of the First Law gives

$$dH = dq - dw + PdV \quad (1.11)$$

which for reversible and only expansion type work becomes

$$dH = dq_p \quad (1.12)$$

or

$$\Delta H = q_p \quad (1.13)$$

Work for selected processes

Equation (1.6) may be integrated for ideal gases under isothermal and isobaric conditions. To give

$$w_p = P(V_2 - V_1) = nR(T_2 - T_1) \quad (1.14)$$

$$w_T = \int_1^2 nRT \frac{dV}{V} = nRT \ln \frac{V_2}{V_1} \quad (1.15)$$

There can be no compression work under isochoric conditions since there is no volume change.

$$w_v = 0 \quad (1.16)$$

Under adiabatic conditions the heat is by definition zero. Therefore, according to the First Law, work is the negative of the change in internal energy.

$$w_{q=0} = -\Delta U \quad (1.17)$$

Heat Capacity

The heat capacity is the amount of heat required to raise the temperature of a material. If the heat capacity is for a specified amount of material, it is an intensive variable. Some texts distinguish between the extensive, or total, heat capacity and the intensive heat capacity. In this text the heat capacity will always refer to the intensive variable. The heat capacity is measured and reported for both isobaric and isochoric conditions as follows:

$$c_v \equiv \frac{1}{n} \left(\frac{\partial q}{\partial T} \right)_v \quad (1.18)$$

$$c_p \equiv \frac{1}{n} \left(\frac{\partial q}{\partial T} \right)_p \quad (1.19)$$

where q is the heat per gmole.

The value of c_v can be determined from Equation (1.5) since all the heat added to an ideal gas at constant volume becomes internal energy. Therefore,

$$c_v \equiv \frac{1}{n} \left(\frac{\partial q}{\partial T} \right)_v = \frac{1}{n} \left(\frac{\partial U}{\partial T} \right)_v = \frac{1}{n} \left(\frac{\partial KE}{\partial T} \right)_v = \frac{1}{n} \left(\frac{\partial (3/2)nRT}{\partial T} \right)_v = \frac{3}{2} R \quad (1.20)$$

The value for c_p for an ideal gas may be found by substituting the First Law into the definition of c_p and recognizing that kinetic energy depends on T only to give

$$c_p \equiv \frac{1}{n} \left(\frac{\partial q}{\partial T} \right)_p = \frac{1}{n} \left(\frac{\partial (U + w)}{\partial T} \right)_p = \frac{1}{n} \left[\left(\frac{\partial KE}{\partial T} \right)_p + \left(\frac{\partial PdV}{\partial T} \right)_p \right] = c_v + R = \frac{5}{2} R \quad (1.21)$$

Heat for selected processes

The computation of heat for isochoric and isobaric processes flow directly from the definitions of c_v and c_p

$$q_v = nc_v \Delta T \quad (1.22)$$

$$q_p = nc_p \Delta T \quad (1.23)$$

For isothermal processes, the First Law requires that the heat associated with a process equals the sum of the work and internal energy. However, the internal energy of an ideal gas is a function of temperature only making its change zero. Therefore, for isothermal processes involving ideal gases

$$q = w = nR \ln \frac{V_2}{V_1} \quad (1.24)$$

Of course, $q = 0$ for adiabatic processes.

ΔU and ΔH for selected processes

Both internal energy and enthalpy are state functions. Any equation that relates a change in a state function for a particular change in state is valid for any path. This means that a derivation for a change in a state function that relies on a certain path as part of the derivation does not encumber the result with the path constraints. For example, in the case of internal energy one may write based on the definition of c_v

$$dq = nc_v dT \quad (1.25)$$

but $dq = dU$ since $dw = 0$ for a constant volume process. Therefore,

$$dU = nc_v dT \quad (1.26)$$

Now the significance of state functions and the above comments come into focus. Even though the derivation relied on the assumption of constant volume, there is no such restriction on the resulting equation because internal energy is a state function. Therefore, the change in internal energy for any process can be computed from

$$\Delta U = nc_v \Delta T \quad (1.27)$$

In the case of enthalpy

$$dq_p = nc_p dT \quad (1.28)$$

but $dq_p = dH$. Therefore,

$$\Delta H = nc_p \Delta T \quad (1.29)$$

for all processes.

Temperature-Pressure-Volume relationships for selected processes

For a specified number of moles, the Ideal Gas Law is a constraint between the three state variables V, P, and T. Specifying any two of these three variables fixes the remaining state variable. If the system then undergoes a specified process (isothermal, isobaric, isochoric, adiabatic), only one final state variable needs to be specified to fix all state variables in the final state. Useful relationships for each of the specified relationships are now given.

$$\text{Isothermal:} \quad PV = \text{constant} \quad \frac{P_1}{P_2} = \frac{V_2}{V_1} \quad (1.30)$$

$$\text{Isochoric:} \quad \frac{P}{T} = \text{constant} \quad \frac{P_1}{P_2} = \frac{T_1}{T_2} \quad (1.31)$$

$$\text{Isobaric:} \quad \frac{V}{T} = \text{constant} \quad \frac{V_2}{V_1} = \frac{T_2}{T_1} \quad (1.32)$$

Reversible adiabatic:

Since this condition involves heat rather than any of the three terms in the Ideal Gas Law, an indirect method for arriving at T-P-V relationships is required. The derivation begins with the First Law with $dq = 0$

$$dU = -dw \quad (1.33)$$

Substitution for each term gives

$$nc_v dT = -PdV \quad (1.34)$$

Substitution of the Ideal Gas Law for P and rearranging gives

$$\frac{dT}{T} = -\frac{R}{c_v} \frac{dV}{V} \quad (1.35)$$

Upon integration the relationship between state 1 and state 2 temperatures and volumes is determined.

$$\left(\frac{T_2}{T_1}\right) = \left(\frac{V_1}{V_2}\right)^{\frac{R}{c_v}} \quad (1.36)$$

The Ideal Gas Law can be used to replace either the temperatures or volumes with pressures to give

$$\left(\frac{T_2}{T_1}\right) = \left(\frac{P_2}{P_1}\right)^{\frac{R}{c_p}} \quad \left(\frac{P_2}{P_1}\right) = \left(\frac{V_1}{V_2}\right)^{\frac{c_p}{c_v}} \quad (1.37)$$

P vs V Plots

The P versus V plot will be used throughout the early chapters of this text so additional discussion of them is warranted. Figure 1.4 shows paths for isobaric, isochoric, isothermal, and adiabatic compression of an ideal gas. The reversible-adiabatic process is steeper than an isothermal process since the work of compression increases the temperature of the gas whereas the temperature remains the same during an isothermal process.

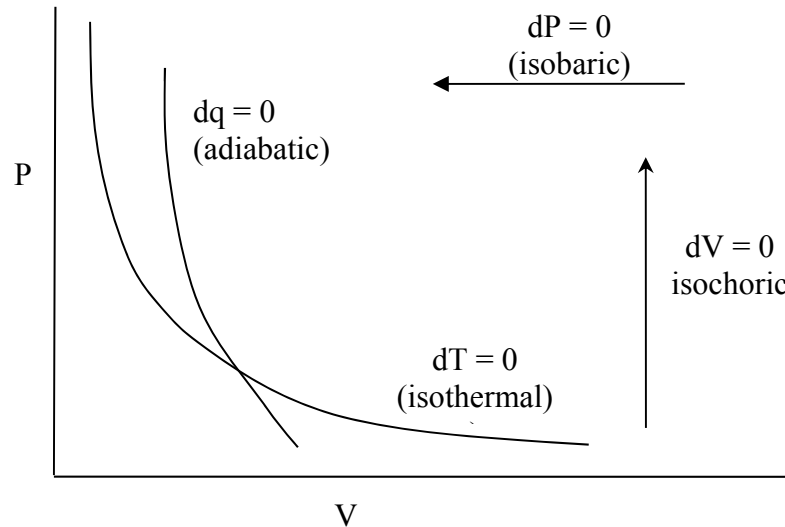

Figure 1-4 Paths for selected processes.

Summary

Table 1 summarizes the equations used to compute work, heat, and changes in internal energy and enthalpy for selected processes as well as the associated T-P-V relationships. By the time students reach their upper-level classes, they should not navigate thermodynamics by attempting to memorize the contents of Table 1 but rather learn to use their previous knowledge to derive the contents of Table 1. The first method is memorization whereas the latter establishes a logical basis of learning that is more enduring than the results of memorization. To this end, the following table is the basis from which everything in Table 1 is obtained. Table 2 reduces to the Ideal Gas Law, work being the integral of PdV , the definitions of heat capacities, and the First Law. The student who can begin with these four fundamental ideas to obtain all of the equations enumerated in Table 1 will find mastering Chapters 1 and 2 greatly simplified compared to the student who tries to memorize or who must continually refer to Table 1.

Table 1 Summary equations for selected ideal gas compression processes

	dT=0	dP=0	dV=0	Rev adiabatic
w	$nRT \ln \frac{V_2}{V_1}$	$P(V_2 - V_1) = nR(T_2 - T_1)$	0	- ΔU
q	w	$nc_p \Delta T$	$nc_v \Delta T$	0
ΔU	0	$nc_v \Delta T$	$nc_v \Delta T$	$nc_v \Delta T$
ΔH	0	$nc_p \Delta T$	$nc_p \Delta T$	$nc_p \Delta T$
T ₂	T ₁	$T_1 \frac{V_2}{V_1}$	$T_1 \frac{P_2}{P_1}$	$T_1 \left(\frac{P_2}{P_1} \right)^{R/c_p} = T_1 \left(\frac{V_1}{V_2} \right)^{R/c_v}$
P ₂	$P_1 \frac{V_1}{V_2}$	P ₁	$P_1 \frac{T_2}{T_1}$	$P_1 \left(\frac{T_1}{T_2} \right)^{c_p/R} = P_1 \left(\frac{V_1}{V_2} \right)^{c_p/c_v}$
V ₂	$V_1 \frac{P_1}{P_2}$	$V_1 \frac{T_2}{T_1}$	V ₁	$V_1 \left(\frac{T_1}{T_2} \right)^{c_v/R} = V_1 \left(\frac{P_1}{P_2} \right)^{c_v/c_p}$

Table 2 Summary of fundamental bases for the equations for selected ideal gas compression processes

	Originating concept	Additional information or result
w	$w = \int_1^2 PdV ;$	$PV = nRT$
q	$c_v \equiv \frac{1}{n} \left(\frac{\partial q}{\partial T} \right)_v ;$ $c_p \equiv \frac{1}{n} \left(\frac{\partial q}{\partial T} \right)_p ;$ $\Delta U = q - w = 0 ;$	dV=0; $q_v = nc_v \Delta T = \Delta U$ dP=0; $q_p = nc_p \Delta T = \Delta H$ dT=0; $q_T = w$
ΔU	$c_v \equiv \frac{1}{n} \left(\frac{\partial q}{\partial T} \right)_v = \frac{1}{n} \left(\frac{\partial U}{\partial T} \right) ;$	$\Delta U = nc_v \Delta T$
ΔH	$c_p \equiv \frac{1}{n} \left(\frac{\partial q}{\partial T} \right)_p = \frac{1}{n} \left(\frac{\partial H}{\partial T} \right) ;$	$\Delta H = nc_p \Delta T$
T ₂ , P ₂ , V ₂	$\frac{P_2 V_2}{T_2} = \frac{P_1 V_1}{T_1}$ $dU = -dw ; \quad nc_v dT = -PdV$	For T ₁ =T ₂ , P ₁ =P ₂ , or V ₁ =V ₂ For reversible adiabatic processes

Example Problems

Problems

There are almost as many formulations of the second law as there have been discussions of it.
— Philosopher / Physicist [P.W. Bridgman](#), (1941)

Chapter 2

The Second Law of Thermodynamics – The Arrow of Time

Basic Concepts

- **The Zeroth Law of Thermodynamics**
- **Definitions**
- **Mathematical Requirements**

If we see a film clip of a match being struck, bursting into flame, and slowly burning out, we think nothing beyond the process as viewed; however, if the clip is run in reverse we are immediately aware that we are observing something impossible. The impossibility of the process is precisely the reason the process grabs our attention. Rocks do not run up hill. Explosions do not collect tiny fractured bits of debris together through a huge fireball that continues to shrink into some undestroyed structure rigged with an explosive device. Each of us has learned from an early age that natural processes have a predictable sequence that is called in this text the *arrow of time*. Learning this arrow of time – the direction of natural processes - provides the predictability necessary to our functioning.

In the case of chemical reactions, we understand the direction of many processes but not all. Processes such as combustion of natural gas with air or the reaction of vinegar with baking soda are known, but few people would know by experience what, if any, reaction might occur if aluminum oxide is mixed with carbon and heated to 1000 °C. It turns out no reaction occurs at atmospheric pressure, but the more interesting question is *can one calculate if a reaction is favorable and what is the basis for making such a computation*. Often students suggest that predicting the down-hill direction of rocks involves nothing more than determining the direction for the reduction of potential energy. That works for rocks but potential energy has no value in trying to predict the direction of chemical reactions. In that case students often - and incorrectly – think that a reaction is favorable if it liberates heat, but if it were so simple then endothermic reactions would never occur: yet they do. Therefore, there must be more to the prediction of reactions than simply thermicity.

The Second Law of Thermodynamics defines a quantity called *entropy* that allows predicting the direction of chemical reactions, the direction rocks roll, and the direction of all physical processes. Figure 2.1 illustrates the direction of change in three systems. In Figure 2.1 a) a pendulum moves from position A towards B while at position B it moves toward A. At equilibrium it rests between A and B. In Figure 2.1 b) spontaneous change is shown in terms of ice and water, which is at equilibrium at ice's melting temperature. Figure c) shows a general spontaneous change and equilibrium in a system comprised of material A and B. In all processes, spontaneous change can be shown to be accompanied by an increase in total entropy.

For an unfamiliar reaction, the direction of the reaction is unknown so one assumes it proceeds as written. For example, a reaction might be assumed to proceed to the right when written as

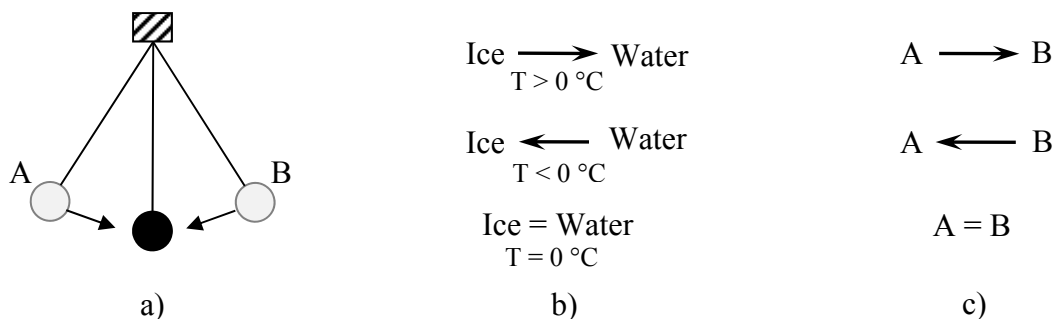

Figure 2.1 Three possible scenarios for a system involving State A and State B.



and the total entropy change computed. If the total entropy change > 0 , then the assumed direction is correct. On the other hand if total entropy change < 0 , then the actual spontaneous process direction is the opposite of the assumed direction and the direction of the reaction is to the left. A zero total entropy change indicates the reaction is at equilibrium. The arrow of time corresponds to increases in total entropy. Such processes are spontaneous or natural processes.

Now that the usefulness of the entropy is established, the value of the Second Law of Thermodynamics from which entropy arises should be greatly appreciated. The Second Law of Thermodynamics is based on observation of the natural world and permits the prediction of the processes direction through the computation of total entropy change. This direction corresponds to the *arrow of time*.

The Second Law of Thermodynamics in verbal form is stated as follows:

It is impossible to take a quantity of heat from a body at uniform temperature and convert it to an equivalent amount of work without changing the thermodynamic state of a second body.

Most students do not find much meaning in this statement of experimental observation. Figure 2.2 is the author's pedagogical device for making the Second Law more understandable. The figure consists of a tank of water at uniform temperature with a thermometer along the left side to measure the water's temperature. A weight on the right side is connected to a mixer inside the tank so that as the weight falls the mixer spins. In the normal course of events, the potential energy of the weight is converted to heat inside the tank of water and the water's temperature increases. However, the Second Law is stated for the impossible case in which heat from the water as indicated on the diagram by the falling water temperature, is converted to work that lifts the weight. This is impossible. It has never been observed and try as one might there has never been a reproducible experiment in which heat from a body at uniform temperature (the water in this case) has been converted to an equivalent amount of work (raising the weight in this case) without changing the

thermodynamic state of a second body. A second body is not needed in the example in Figure 2.2 since there is no change in any such body in the impossible case.

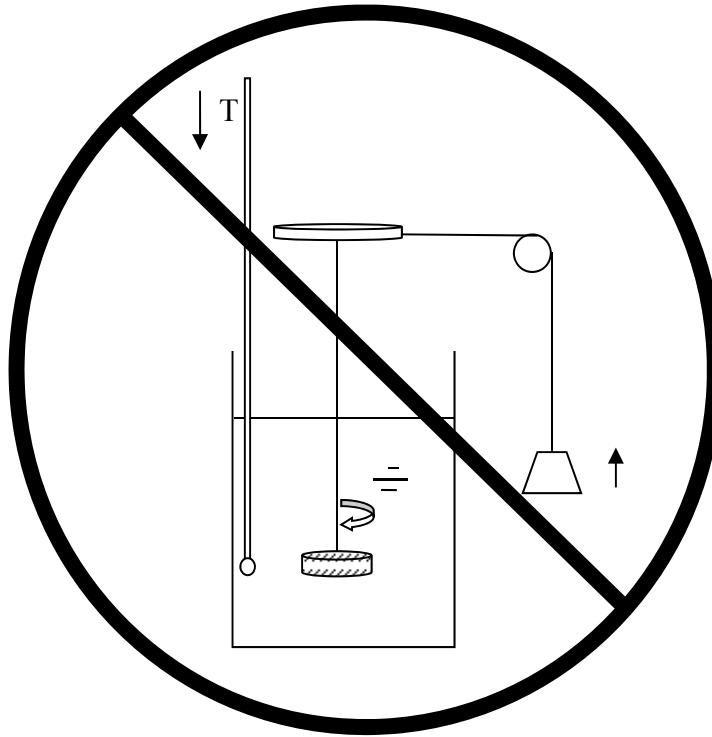

Figure 2.2 The Second Law of Thermodynamics in graphical format.

The mathematical statement of the Second Law is for a closed system

$$\left(\frac{dq}{T}\right)_{Rev} \geq 0 \quad Irrev \quad (2.2)$$

The left term is the definition of entropy change.

$$dS \equiv \left(\frac{dq}{T}\right)_{Rev} \quad (2.3)$$

The definition requires that the change in entropy is computed under the constraint of reversible conditions. There are two primary processes that will be of interest in this chapter: heat transfer and gas expansion. Reversible means different conditions for each. For heat transfer the entropy change for a single body is computed using the body's temperature for the T in the denominator of the definition of entropy. In the case of gas expansion, reversible requires that the expansion occurs reversibly, which means that the gas performs maximum work during the expansion. It makes no difference if the actual expansion occurred reversibly. Gas compression is always reversible so maximum work is always performed during compression.

When a gas undergoes expansion, the entropy change for the gas is the same regardless of whether maximum work was derived from the expansion or not. However, this does not mean that the total entropy change for the expansion is the same because the total entropy change includes the change in the heat sink, which undergoes a considerably different entropy change depending on how much work the gas actually does during the expansion. It is important to remember that reversible means different conditions for different kinds of processes. For the gas it means maximum work: for the heat sink it means the T in Equation (2.3) is the temperature of the heat sink and has nothing to do with the amount of heat transferred to the gas as it undergoes its expansion – reversibly or not.

Example 2.1: Find the total entropy change for 1000 joules of heat conducting from a massive body of copper at 500K to another massive body of iron at 400 K.

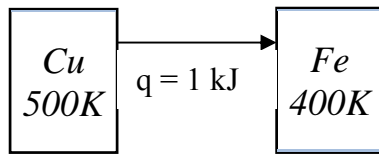

$$\Delta S_{\text{Cu}} = \int dS = \int \left(\frac{dq}{T} \right)_{\text{Rev}} = \int \frac{dq}{T_{\text{Cu}}} = \frac{q}{T_{\text{Cu}}} = \frac{-1000 \text{ J}}{500 \text{ K}} = -2.0 \frac{\text{J}}{\text{K}}$$

$$\Delta S_{\text{Fe}} = \int dS = \int \left(\frac{dq}{T} \right)_{\text{Rev}} = \int \frac{dq}{T_{\text{Fe}}} = \frac{q}{T_{\text{Fe}}} = \frac{1000 \text{ J}}{400 \text{ K}} = 2.5 \frac{\text{J}}{\text{K}}$$

$$\Delta S_{\text{Total}} = \Delta S_{\text{Cu}} + \Delta S_{\text{Fe}} = 0.5 \frac{\text{J}}{\text{K}} > 0 \text{ Possible}$$

Example 2.2: Find the total entropy change for 1000 joules of heat conducting from a massive body of copper at 500K to another massive body of iron at 500 K.

$$\Delta S_{\text{Cu}} = \int dS = \int \left(\frac{dq}{T} \right)_{\text{Rev}} = \int \frac{dq}{T_{\text{Cu}}} = \frac{q}{T_{\text{Cu}}} = \frac{-1000 \text{ J}}{500 \text{ K}} = -2.0 \frac{\text{J}}{\text{K}}$$

$$\Delta S_{\text{Fe}} = \int dS = \int \left(\frac{dq}{T} \right)_{\text{Rev}} = \int \frac{dq}{T_{\text{Fe}}} = \frac{q}{T_{\text{Fe}}} = \frac{1000 \text{ J}}{500 \text{ K}} = 2.0 \frac{\text{J}}{\text{K}}$$

$$\Delta S_{\text{Total}} = \Delta S_{\text{Cu}} + \Delta S_{\text{Fe}} = 0 \frac{\text{J}}{\text{K}} \text{ Equilibrium}$$

Example 2.3: Find the total entropy change for 1000 joules of heat conducting from a massive body of copper at 400K to another massive body of iron at 500 K, which is impossible.

$$\Delta S_{\text{Cu}} = \int dS = \int \left(\frac{dq}{T} \right)_{\text{Rev}} = \int \frac{dq}{T_{\text{Cu}}} = \frac{q}{T_{\text{Cu}}} = \frac{-1000 \text{ J}}{400 \text{ K}} = -2.5 \frac{\text{J}}{\text{K}}$$

$$\Delta S_{Fe} = \int dS = \int \left(\frac{dq}{T} \right)_{Rev} = \int \frac{dq}{T_{Fe}} = \frac{q}{T_{Fe}} = \frac{1000 J}{500 K} = 2.0 \frac{J}{K}$$

$$\Delta S_{Total} = \Delta S_{Cu} + \Delta S_{Fe} = -0.5 \frac{J}{K} < 0$$

Impossible, The heat actually goes the other direction.

Example 2.4: Find the total entropy change when a rock at 300 K rolls down a hill. Assume the rock's potential energy change, which ends up as heat in the hill, equals 3,000 Joules and that the rock (after some time) returns to its original temperature of 300 K.

$$\Delta S_{Hill} = \int dS = \int \left(\frac{dq}{T} \right)_{Rev} = \int \frac{dq}{T_{Hill}} = \frac{q}{T_{Hill}} = \frac{3000 J}{300 K} = 10 \frac{J}{K}$$

$$\Delta S_{Rock} = \int dS = \int \left(\frac{dq}{T} \right)_{Rev} = 0$$

$$\Delta S_{Total} = \Delta S_{Hill} + \Delta S_{Rock} = 10 \frac{J}{K} > 0 \text{ Possible}$$

Example 2.5: Find the total entropy change for the isothermal expansion of two moles of ideal gas at 10 atm and 500 K to 1 atm in contact with a heat sink at 500 K while performing a) maximum work, b) 70 percent of the maximum work, c) no work.

The entropy change for the gas is the same regardless of how much work the gas actually does during the expansion.

$$\Delta S_{Gas} = \int dS = \int \left(\frac{dq}{T} \right)_{Rev} = \int \frac{dw_{Max}}{T_{Gas}} = \frac{w_{Max}}{T_{Gas}} = \frac{nRT \ln\left(\frac{10}{1}\right)}{T_{Gas}} = 2R \ln(10)$$

The entropy change for the sink is the amount of heat from the sink divided by the sink's temperature. The amount of heat from the sink to the gas is the same as the work actually performed by the gas. The gas's heat gain is the sink's loss; therefore

$$q_{Sink} = -q_{Gas}$$

and

$$\Delta S_{Sink} = \int dS = \int \left(\frac{dq}{T} \right)_{Rev} = \int \frac{-dq_{Gas}}{T_{Sink}} = \frac{-q_{Gas}}{T_{Sink}} = \frac{-q_{Gas}}{500 K}$$

a) Maximum work

$$q_{Gas} = nRT \ln(10)$$

$$\Delta S_{Total} = \Delta S_{Gas} + \Delta S_{Sink} = 2R \ln(10) - 2R \ln(10) = 0$$

Reversible process conducted under equilibrium conditions

b) 70 Percent maximum work

$$q_{Gas} = 0.7nRT \ln(10)$$

$$\Delta S_{Total} = \Delta S_{Gas} + \Delta S_{Sink} = 2R \ln(10) - 1.4R \ln(10) = 0.6R \ln(10) > 0$$

Possible and conducted under irreversible conditions

c) No work

$$q_{Gas} = 0$$

$$\Delta S_{Total} = \Delta S_{Gas} + \Delta S_{Sink} = 2R \ln(10) - 0 = 2R \ln(10) > 0$$

Possible but conducted under irreversible conditions

Example 2.6: Find the total entropy change for the same conditions as Example 2.5a except for a sink temperature of a) 700 K and b) 300 K.

The entropy change for the gas is the same regardless of how the much work the gas actually does during the expansion.

$$\Delta S_{Gas} = 2R \ln(10)$$

The entropy change for the sink is as before

$$\Delta S_{Sink} = \int dS = \int \left(\frac{dq}{T} \right)_{Rev} = \int \frac{-dq_{Gas}}{T_{Sink}} = \frac{-q_{Gas}}{T_{Sink}} = \frac{-2R(500K) \ln(10)}{T_{Sink}}$$

a) Sink T=700 K

$$\Delta S_{Total} = \Delta S_{Gas} + \Delta S_{Sink} = 2R \ln(10) - \frac{2R(500K) \ln(10)}{700 K} = \frac{4R \ln(10)}{7} > 0$$

Possible but conducted under irreversible conditions.

a) Sink T=300 K

$$\Delta S_{Total} = \Delta S_{Gas} + \Delta S_{Sink} = 2R \ln(10) - \frac{2R(500K) \ln(10)}{300 K} = -\frac{4R \ln(10)}{3} < 0$$

Impossible because heat cannot flow from a 300 K heat sink into a gas at 500 K; however, the process could occur in the opposite direction (i.e. - compression rather than expansion).

The Four Propositions

The Second Law of Thermodynamics is said to be stated as many ways as those writing about it. The statement used in this chapter is based on Denbigh¹. Denbigh's treatment of thermodynamics in *Principles of Chemical Equilibrium* is beautifully concise and formal. It is recommended for students who have completed the corresponding subjects in this text. Denbigh presents four propositions arising from the Second Law statement. The proofs for these propositions are given in Appendix A. The propositions are stated here.

Proposition 1

For a Carnot cycle operating between a heat sink at hotness t_1 and hotter sink at hotness t_2 and exchanging the corresponding heats q_1 and q_2 to the working fluid that

$$\frac{q_2}{q_1} = f(t_2, t_1) \quad (2.4)$$

Proposition 2

The Thermodynamic Temperature Scale is defined by the ratio of heats exchanged in a Carnot cycle.

$$\frac{|q_2|}{|q_1|} = \frac{f(t_2)}{f(t_1)} = \frac{T_2}{T_1} \quad (2.5)$$

Proposition 3

Entropy defined as

$$dS \equiv \left(\frac{dq}{T} \right)_{Rev} \quad (2.6)$$

is a state function.

Proposition 4

The change in entropy is zero for a reversible process and greater than zero for an irreversible process.

$$dS \geq 0 \begin{matrix} Irrev \\ Rev \end{matrix} \quad (2.7)$$

Chapter 3

The Third Law of Thermodynamics and Entropy of Mixing

Basic Concepts

- Heat capacity's variation with temperature
- Entropy of pure crystalline materials at absolute zero
- Entropy of ideal mixing

Experimental measurements for the heat capacity of a pure crystalline material have the form shown in Figure 3.1. As the temperature approaches absolute zero, the heat capacity not only approaches zero but so does its slope. The reason for this is that as the temperature is lowered towards absolute zero the crystalline structure has fewer and fewer ways of storing energy. At absolute zero there is no additional way to store or remove energy from the crystal. According to Equation(2.3), the zero slope of C_p as the temperature approaches absolute zero requires a constant value of entropy.

$$dS = \lim_{T \rightarrow 0} \left(\frac{dq}{T} \right)_{Rev} = \lim_{T \rightarrow 0} \frac{C_p dT}{T} = \lim_{T \rightarrow 0} C_p d \ln(T) = 0 \quad (3.1)$$

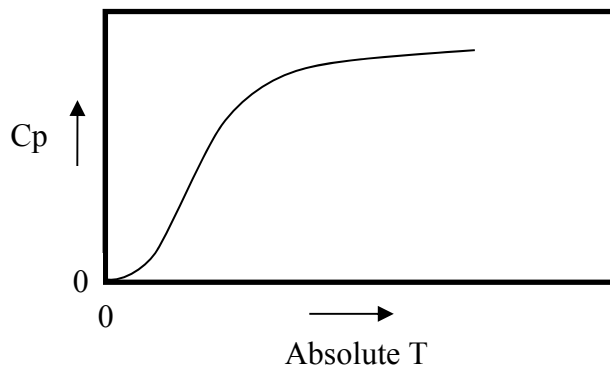

Figure 3.1 Heat capacity's variation with absolute temperature

In 1923 [Gilbert N. Lewis](#) and [Merle Randall](#) stated the Third Law of Thermodynamics as follows:

If the entropy of each element in some (perfect) crystalline state be taken as zero at the absolute zero of temperature, every substance has finite positive entropy; but at the absolute zero of temperature the entropy may become zero, and does so become in the case of perfect crystalline substances. http://en.wikipedia.org/wiki/Third_law_of_thermodynamics

The value of the Third Law is that the entropy is a material property that may be computed from experimental data. Since the entropy of a pure crystalline substance is zero at absolute zero, the absolute value of entropy may be computed at higher temperatures by integrating Equation (2.3) where $dq = C_p dT$ to give

$$S_T = \int_0^T \frac{C_p dT}{T} \quad (3.2)$$

Entropy of Mixing: configurational entropy

The total entropy change for spontaneous processes is greater than zero. This has been shown true for all processes and illustrated for gas expansion processes and for heat exchange. A third spontaneous change observed in nature is that of mixing. When two gases are placed in the same container, they spontaneously mix. The previous treatment does not offer a way by which the entropy of mixing may be computed.

Boltzmann considered mixing from the atomistic perspective. He considered the probabilities of various mixing arrangements or configurations. For a system of atoms of A and B where each A is indistinguishable from other A atoms and the same being true for atoms of B, the entropy of the system of atoms is then given by

$$S = k \ln \Omega \quad (3.3)$$

where k = Boltzmann's constant (R/Avogadro's Number)

Ω = Number of configurations

In the case of six atoms of A and six atoms of B, the number of mixed configurations is computed as

$$\Omega = \frac{(N_A + N_B)!}{N_A! N_B!} = \frac{12!}{6! 6!} = 924$$

Since the entropy of the unmixed system has only one configuration, its entropy is 0. Therefore, the entropy of mixing for this ideal mixing process is

$$S^{M,ID} = k \ln(924).$$

For systems composed of large numbers of atoms, large factorials become an imposing computational obstacle. This can be overcome by employing Sterling's Approximation for large factorials

$$\ln N! \approx N \ln N - N \quad (3.4)$$

In the case that $N_A + N_B = \mathcal{A}$ Avogadro's Number, the entropy of mixing for one mole of atoms is

$$\begin{aligned}
S^{M, ID} &= k \ln \left[\frac{(N_A + N_B)!}{N_A! N_B!} \right] \\
&= k(N_A + N_B) \ln[(N_A + N_B)] - (N_A + N_B) \\
&\quad - [kN_A \ln(N_A) - N_A] - [kN_B \ln(N_B) - N_B]
\end{aligned} \tag{3.5}$$

which becomes

$$S^{M, ID} = -R[x_A \ln x_A + x_B \ln x_B] \tag{3.6}$$

where $R = \mathcal{A}k$, $x_A = \frac{N_A}{N_A + N_B}$, $x_B = \frac{N_B}{N_A + N_B}$

Example

What is the configurational entropy change for 2 moles of Au mixing with 8 moles of Ag?

Solution:

$$x_{Au} = \frac{2}{2+8} = 0.2 \qquad x_{Ag} = \frac{8}{2+8} = 0.8$$

$$S^{M, ID} = -R[0.2 \ln(0.2) + 0.8 \ln(0.8)], \text{ per mole}$$

$$\text{Answer: } S^{M, ID} = -10S^{M, ID}, \text{ for 10 moles}$$

Chapter 4

The Auxiliary Equations - The Equation Tool Kit

Basic Concepts

- **Auxiliary Functions**
- **Fundamental Equations for a Closed System**
- **Thermodynamic Relationships deriving from the Total Differential**
- **Maxwell Relationships**
- **The Criteria of Equilibrium**
 - **Constant T and V**
 - **Constant T and P**
- **The Gibbs-Helmholtz Equation**
- **Chemical Potential**
- **Fundamental Equations for an Open System**

This chapter consists of defining the auxiliary functions, which are useful combinations of previously-known state functions such as U, P, V, T, and S. These auxiliary functions are defined for convenience only. That is to say that the groups of state functions are particularly useful and so commonly used that assigning these combinations of variables their own names makes using them easier.

Auxiliary Functions

The auxiliary functions are defined as follows:

$$\text{Enthalpy:} \quad H \equiv U + PV \quad (4.1)$$

$$\text{Helmholtz Energy:} \quad A \equiv U - TS \quad (4.2)$$

$$\text{Gibbs Energy:} \quad G \equiv H - TS \quad (4.3)$$

It has been shown in Chapter 2 that a change in enthalpy corresponds to the heat for a process conducted reversibly at constant pressure. Helmholtz energy will be shown below to be the criterion of equilibrium for a system at constant T and V while Gibbs energy is the criterion for equilibrium in systems at constant T and P.

Fundamental Equations for a Closed System

The first of the four Fundamental Equations for a closed system is obtained by substituting into the First Law the definition of entropy and PdV for maximum work.

$$dU = TdS - PdV \quad (4.4)$$

Since the definition of entropy requires reversible conditions, the corresponding maximum work is substituted for the work term. The resulting equation might be thought to apply only to reversible processes since it was derived making such an assumption but this is not a constraint that needs to be maintained since all of the terms in the resulting fundamental equation are state variables. That is, the changes in the state variables in Equation (4.4) are the same for a process whether conducted reversibly, or not.

The remaining three fundamental equations are obtained by differentiating each auxiliary equation and substituting Equation (4.4) and the resulting fundamental equations to obtain

$$dH = TdS + VdP \quad (4.5)$$

$$dA = -PdV - SdT \quad (4.6)$$

$$dG = VdP - SdT \quad (4.7)$$

Thermodynamic relationships derived from the total differential

The total differential for a function $z(x, y)$ is

$$dz = \left(\frac{\partial z}{\partial x} \right)_y dx + \left(\frac{\partial z}{\partial y} \right)_x dy \quad (4.8)$$

If each of the Fundamental Equations are written in terms of the differands, an equation may be written for each state variable in terms of the slope of the independent variable. For example, for the first Fundamental Equation, $U(S, V)$, for which the total differential is

$$dU = \left(\frac{\partial U}{\partial S} \right)_V dS + \left(\frac{\partial U}{\partial V} \right)_S dV \quad (4.9)$$

Comparison of the coefficients for dS and dV gives

$$T = \left(\frac{\partial U}{\partial S} \right)_V \quad \text{and} \quad P = - \left(\frac{\partial U}{\partial V} \right)_S \quad (4.10)$$

Continuing this process for all of the fundamental equations gives the following relationships:

$$T = \left(\frac{\partial U}{\partial S} \right)_V = \left(\frac{\partial H}{\partial S} \right)_P \quad (4.11)$$

$$P = - \left(\frac{\partial U}{\partial V} \right)_S = - \left(\frac{\partial A}{\partial V} \right)_T \quad (4.12)$$

$$V = \left(\frac{\partial H}{\partial P} \right)_S = \left(\frac{\partial G}{\partial P} \right)_T \quad (4.13)$$

$$S = - \left(\frac{\partial A}{\partial T} \right)_V = - \left(\frac{\partial G}{\partial T} \right)_P \quad (4.14)$$

Maxwell Relations

The Maxwell Relations are a consequence of the quality of exactness, which for function $z(x, y)$ is

$$\left. \frac{\partial \left(\frac{\partial z}{\partial x} \right)_y}{\partial y} \right)_x = \left. \frac{\partial \left(\frac{\partial z}{\partial y} \right)_x}{\partial x} \right)_y \quad (4.15)$$

For the first Fundamental Equation, the function $U = f(S, V)$ the quality of exactness is written as

$$\left. \frac{\partial \left(\frac{\partial U}{\partial S} \right)_V}{\partial V} \right)_S = \left. \frac{\partial \left(\frac{\partial U}{\partial V} \right)_S}{\partial S} \right)_V \quad (4.16)$$

Substituting Equation (4.11) into Equation (4.16) gives the first Maxwell Relation.

$$\left. \frac{\partial T}{\partial V} \right)_S = - \left. \frac{\partial P}{\partial S} \right)_V \quad (4.17)$$

Repeating for the remaining three fundamental equations gives the remaining three Maxwell Relations.

$$\left. \frac{\partial T}{\partial P} \right)_S = \left. \frac{\partial V}{\partial S} \right)_P \quad (4.18)$$

$$\left. \frac{\partial P}{\partial T} \right)_V = \left. \frac{\partial S}{\partial V} \right)_T \quad (4.19)$$

$$\left. \frac{\partial V}{\partial T} \right)_P = - \left. \frac{\partial S}{\partial P} \right)_T \quad (4.20)$$

Criteria of Equilibrium

The Helmholtz energy was defined to describe the criterion on equilibrium at constant T and V . This is shown by considering a change in A

$$dA = dU - d(TS) \quad (4.21)$$

From the First Law and imposing $dT = 0$ gives

$$dA = dq - dw - TdS \quad (4.22)$$

if the work is comprised of expansion-type work (PdV), which is zero, and other work dw' , then

$$dA = dq - TdS - dw' \quad (4.23)$$

For a reversible process, $dq = TdS$. For an irreversible process, such as an expansion of a gas, $|dq|$ is always less than TdS . Since $dS > 0$ and $dq < 0$, $dq - TdS$ is negative and

$$dA \leq -dw' \quad (4.24)$$

Therefore, a system at constant T and V that performs no w' , will reach equilibrium at minimum Helmholtz energy as shown in Figure 4.1. Furthermore, the maximum w' that a system at constant T and V can produce is $-dA$.

The Gibbs energy was defined to describe the criterion on equilibrium at constant T and P . This is shown by considering a change in G

$$dG = dH - d(TS) \quad (4.25)$$

Substituting for $dH = dU + d(PV)$ and the First Law gives

$$dG = dq - PdV - dw' + PdV - TdS \quad (4.26)$$

which reduces to the same right hand side as Equation (4.23). Using the same logic for arriving at Equation (4.24) gives

$$dG \leq -dw' \quad (4.27)$$

Therefore, a system at constant T and P that performs no w' , will reach equilibrium at minimum Gibbs energy as shown in Figure 4.2. Furthermore, the maximum w' that a system at constant T and P can produce is $-dG$.

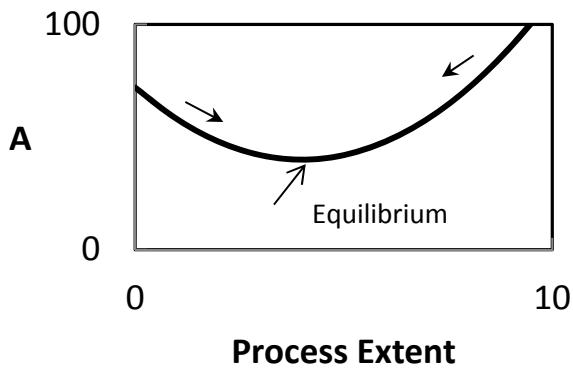

Figure 4.1 Processes at Constant T and V with expansion only work move towards minimum Helmholtz energy.

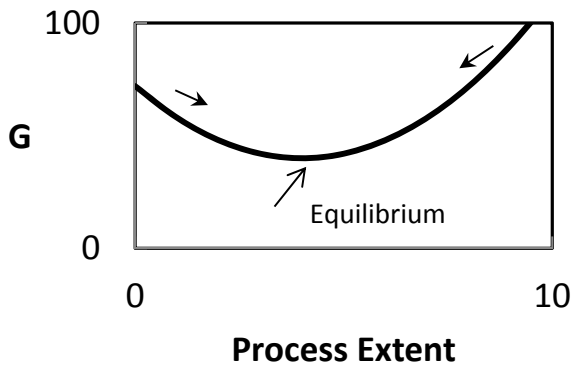

Figure 4.2 Processes at Constant T and P with expansion only work move towards minimum Gibbs energy.

Gibbs-Helmholtz Equation

Gibbs energy is use frequently because most systems of practical interest are at constant temperature and pressure. Since temperature is a major system variable under the control of the experimentalist or the processing engineer, the question naturally arises about the effect of changing a system’s temperature on G. This is easily determined by the Gibbs-Helmholtz Equation, which is derived by substituting Equation (4.14) into the definition of Gibbs energy.

$$G = H - ST = H + \left. \frac{\partial G}{\partial T} \right)_P T \tag{4.28}$$

Multiplying by dT and rearranging while constraining the equation for constant P gives

$$TdG - GdT = -HdT \quad (4.29)$$

which may be written

$$\frac{d(G/T)}{dT} = -\frac{H}{T^2} \quad (4.30)$$

or

$$\frac{d(G/T)}{d(1/T)} = H \quad (4.31)$$

The Gibbs-Helmholtz Equation could be written for two states and the difference in the equations for the two states would be

$$\frac{d(\Delta G/T)}{d(1/T)} = \Delta H \quad (4.32)$$

If ΔH and ΔG are for a chemical reaction, the Gibbs-Helmholtz Equation shows that an endothermic ($\Delta H > 0$) reaction becomes more favorable (ΔG decreases) with increasing T.

Chemical Potential

Chemical potential is as important to chemical processing as voltage is to electrical engineering. Chemical potential is defined as

$$\mu_i = \left. \frac{\partial G}{\partial n_i} \right)_{T, P, n_{\text{other}}} \quad (4.33)$$

The chemical potential of a component is the Gibbs energy per mole of that component. It can apply to a component in the pure solid or liquid state, the gaseous state, or in a solid or liquid solution. To understand the concept, one may think of the total Gibbs energy of a system, G, composed of a large number of moles of not only component i but also other components, n_{other} . The addition of one mole of component i, $dn_i = 1$, to the system will change the systems Gibbs energy by dG. This change while keeping T and P constant is the Gibbs energy of that one mole of component i in the system. Of course one could add less than one mole of component i, dn_i , and the change per mole would remain the same. The chemical potential is simply the slope of a plot of G vs. n_i while keeping T, P, and n_{other} remain constant as shown in Figure 4.3.

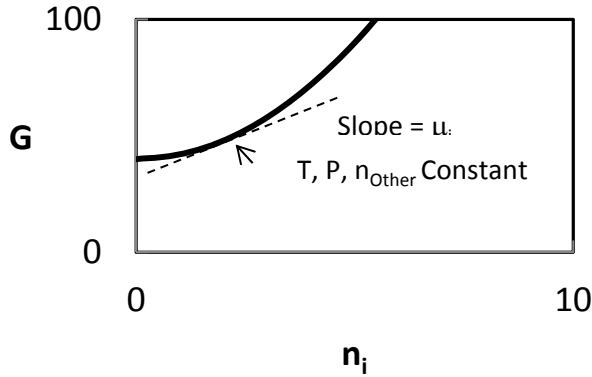

Figure 4.3 The chemical potential is the slope of a plot of the total system G vs. n_i while keeping T , P , and n_{other} constant.

Fundamental Equations for open systems

The first of the four Fundamental Equations is derived by writing the same function relationship for U as used in the derivation of Equation (4.10) but including the moles of the components that may be changing (entering or leaving) in system $U(S, V, n_1, n_2, \dots, n_j)$. The total differential is then

$$dU = \left(\frac{\partial U}{\partial S} \right)_{V, n_{\text{Other}}} dS + \left(\frac{\partial U}{\partial V} \right)_{S, n_{\text{Other}}} dV + \sum_{i=1}^J \left(\frac{\partial U}{\partial n_i} \right)_{V, S, n_{\text{Other}}} dn_i \quad (4.34)$$

The first two differentials are known from Equations (4.11)-(4.14) to be T and $-P$. Therefore,

$$dU = TdS - PdV + \sum_{i=1}^J \left(\frac{\partial U}{\partial n_i} \right)_{V, S, n_{\text{Other}}} dn_i \quad (4.35)$$

Repeating this same procedure for the remaining three Fundamental Equations gives

$$dH = TdS + VdP + \sum_{i=1}^J \left(\frac{\partial H}{\partial n_i} \right)_{S, P, n_{\text{Other}}} dn_i \quad (4.36)$$

$$dA = -PdV - SdT + \sum_{i=1}^J \left(\frac{\partial A}{\partial n_i} \right)_{V, T, n_{\text{Other}}} dn_i \quad (4.37)$$

$$dG = VdP - SdT + \sum_{i=1}^J \left(\frac{\partial G}{\partial n_i} \right)_{T, P, n_{\text{Other}}} dn_i \quad (4.38)$$

Each of the summation terms can be shown to be equal by substituting Equation (4.35) into the definitions of H, A, and G. In the case of H this gives

$$dH = dU + PdV + VdP = TdS - PdV + \left. \sum_{i=1}^J \frac{\partial U}{\partial n_i} \right)_{V, S, n_{Other}} dn_i + PdV + VdP \quad (4.39)$$

$$dH = TdS + VdP + \left. \sum_{i=1}^J \frac{\partial U}{\partial n_i} \right)_{V, S, n_{Other}} dn_i \quad (4.40)$$

Comparison of Equation (4.40) and Equation (4.36) gives the desired result.

$$\left. \sum_{i=1}^J \frac{\partial H}{\partial n_i} \right)_{S, P, n_{Other}} dn_i = \left. \sum_{i=1}^J \frac{\partial U}{\partial n_i} \right)_{V, S, n_{Other}} dn_i \quad (4.41)$$

By the same procedure, the following may also be shown

$$\left. \sum_{i=1}^J \frac{\partial A}{\partial n_i} \right)_{V, T, n_{Other}} dn_i = \left. \sum_{i=1}^J \frac{\partial U}{\partial n_i} \right)_{V, S, n_{Other}} dn_i \quad (4.42)$$

and

$$\left. \sum_{i=1}^J \frac{\partial H}{\partial n_i} \right)_{S, P, n_{Other}} dn_i = \left. \sum_{i=1}^J \frac{\partial G}{\partial n_i} \right)_{T, P, n_{Other}} dn_i \quad (4.43)$$

The right term is the definition of the chemical potential defined in Equation (4.33). Therefore, each of the summation terms may be replaced with the chemical potential to give the Fundamental Equations for an open system.

$$dU = TdS - PdV + \sum_{i=1}^j \mu_i dn_i \quad (4.44)$$

$$dH = TdS + VdP + \sum_{i=1}^j \mu_i dn_i \quad (4.45)$$

$$dA = -PdV - SdT + \sum_{i=1}^j \mu_i dn_i \quad (4.46)$$

$$dG = VdP - SdT + \sum_{i=1}^j \mu_i dn_i \quad (4.47)$$

The Fundamental Equations for a closed system are the same except the summation terms are all zero since the number of moles of each species remains constant in a closed system.

Chapter 5

Enthalpy and Entropy Changes

Basic Concepts

- **Three kinds of enthalpy and entropy changes**
sensible, phase transformation, and reaction
- **Arbitrary-defined system for Enthalpy:** $H_{i,T}^{\circ}$
- **Enthalpies of formation:** $\Delta H_{Form,T}^{\circ}$
- **Entropy:** S_T°
- **Enthalpy of reaction at 298 K from heats of formation:** $\Delta H_{R,T}^{\circ}$
- **Calculation schematic for enthalpies and entropies at T other than 298 K**
- **Gibbs energy of reaction:** $\Delta G_{R,T}^{\circ}$
- **Uses of the calculation Schematic**
 - **Adiabatic flame temperature:** T_{AFT}
 - **Transformation reaction values at T other than the equilibrium T**
- **Databases: JANAF, ThermoCalc[®]**

By this end of this chapter, the student will be able to calculate whether a chemical reaction will occur at a specified temperature. This will be accomplished by calculating the change in the Gibb's energy of the reaction, which from Equation (4.3) is

$$\Delta G_{R,T}^{\circ} = \Delta H_{R,T}^{\circ} - T\Delta S_{R,T}^{\circ} \quad (5.1)$$

at constant T. One sees from this the importance of being able to compute $\Delta H_{R,T}^{\circ}$ and $\Delta S_{R,T}^{\circ}$. The means of performing such computations presented now.

Three kinds of enthalpy and entropy changes

Heat can be stored or released from a material in three ways. *Sensible heat* is the heat that changes the temperature of the material. It is related to the heat capacity of the material. It is called *sensible heat* because one can sense the flow of heat from a warm or cold object. In either case, heat is flowing from or to the material touched and either cools down or warms up because of the loss or gain of heat. Equation (1.19) may be rearranged and integrated to find sensible enthalpy (heat) changes.

$$\Delta H_{Sens} = \int_{T_1}^{T_2} Cp dT \quad (5.2)$$

The definition of entropy given in Equation (2.3), may be integrated to find sensible entropy changes.

$$\Delta S_{Sens} = \int_{T_1}^{T_2} \frac{Cp}{T} dT \quad (5.3)$$

Phase transformation heat is the heat required or released because of a phase change such the melting of ice or the vaporization (boiling) of water. Melting ice or boiling water remains at the same temperature during the phase transformation process. *Phase transformation heat* is also called *latent heat* first observed scientifically by Scottish Joseph Black in 1775. Some claim this to be the beginning of Thermodynamics. James Watt used it to improve the steam engine and the spirit distillation industry (scotch distillers) better understood their craft as well. Figure 5.1 shows a typical plot of T vs. time of a pure, molten Pb as it cools to its melting point and then further cools. Note how the cooling rate of the hot molten lead slows as its temperature decreases followed by a long period at constant temperature while the heat of fusion is given up as the Pb goes from a liquid to a solid. After complete solidification, the temperature drop resumes at the same rate as the cooling liquid just above the melting point but slows more slowly as it becomes cooler. Values for the enthalpy (heat) of a phase transformation must be determined experimentally. Values for computations are obtained from thermochemical databases.

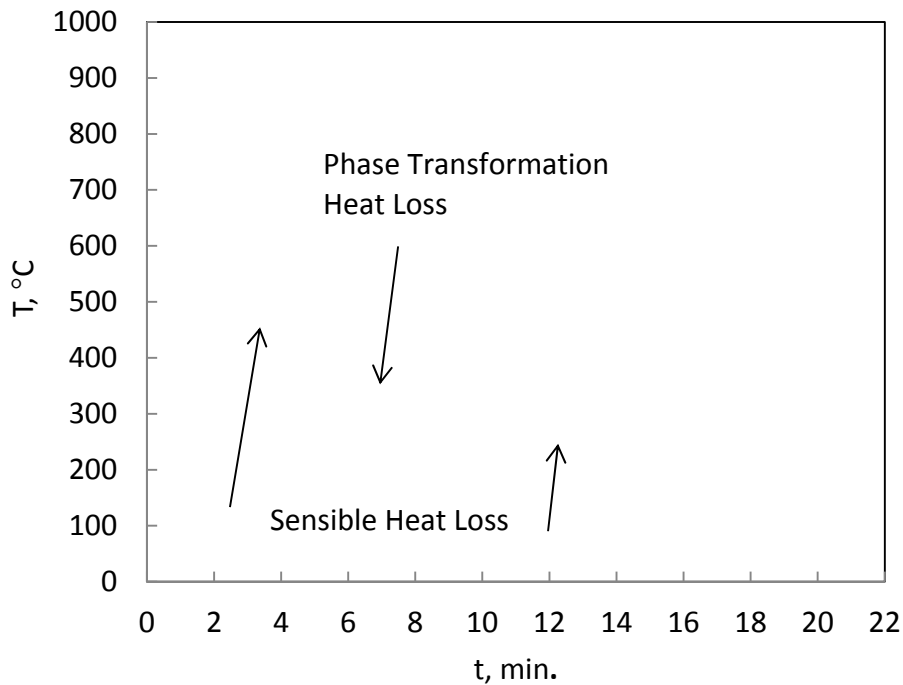
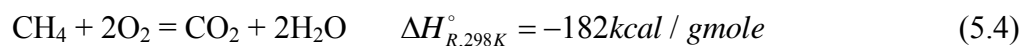

Figure 5.1 Cooling curve for solidification of Molten Pb

The *heat of reaction* is the heat released or required when a chemical reaction occurs. The most common example of a *heat of reaction* is combustion. For example, the burning of methane produces heat.



Values for the enthalpy (heat) of reaction must be determined from experimental data. Values for computations are obtained from thermochemical databases. The next section

describes how the data required to compute the nearly countless possible reactions can be obtained from a relative few heats of reaction; namely, from heats of formation.

Heats (enthalpies) of formation

Table 5.1 Heats of transformation for selected compounds and elements

Species	State	Transformation Temperature K	$\Delta H_{Tran,298K}^\circ$ (cal/gmole)
C	graphite \rightarrow diamond	298*	453
Cu	s \rightarrow l	1356	3,170
Cu	l \rightarrow g	2848	72,743
H ₂ O	s \rightarrow l	273	1,436
H ₂ O	l \rightarrow g	373	9,718
Zr	$\alpha \rightarrow \beta$	1134	960

* Not at equilibrium

Data from JANAF Thermochemical Tables and ThermoCalc

Enthalpy of formation

The heat of formation for any compound or element at a specified temperature is defined as the enthalpy change associated with the reaction to form the element or compound from the most stable form of elements at the specified temperature. For example the heat of formation for carbon dioxide gas at 500 K is the enthalpy change for the reaction



Elements in their most stable form have a zero heat of formation by definition, but elements not in their most stable form are not zero. For example, the heat of formation reaction for diamond at 298 K is 453 cal/gmole.



Table 5.2 shows selected heats of formation at 298 K. The entropies values in Table 5.2 will be discussed a little later in this chapter.

All of the enthalpies, be they sensible, transformation, or reaction, are changes in H: not absolute values of enthalpy. Indeed, one cannot determine the absolute entropy value because it is defined in terms of the internal energy ($H \equiv U+PV$), which in turn is not knowable. Such energy would include all the energy of bonding, electron motion, as well as the energy of all the subatomic particles that comprise protons, neutrons, and electrons. Perhaps, at some level the very mass might be thought of as energy since the two are related ($e = mc^2$). Consequently, we accept that absolute enthalpy is not measurable, but rather

changes in enthalpy are. Sensible heat is calculable from the temperature change using Equation (5.2); transformation heats are measured as the change in heat required to transform a material from one state to another; reaction heat is the heat associated with reactants becoming products.

Table 5.2 Heats of formation and entropies at 298 K for selected compounds and elements

Species	State	$\Delta H_{Form,298K}^{\circ}$ (cal/gmole)	S_{298K}° (cal/K•gmole)
C	diamond	453	0.566
C ₆₀	buckyballs	578,590	423
CH ₄	g	-17,895	44.49
CO	g	-26,417	47.21
CO ₂	g	-94,054	51.07
H ₃ PO ₄	s	-301,530	26.42
H ₂ O	s	-68,952	139.94
H ₂ O	l	-67,516	16.71
H ₂ O	g	-57,798	45.11
Hg	s	549	18.17
Hg	g	14,652	41.79
O ₃	g	34,100	57.08

Arbitrary-defined system for Enthalpy

This need to always refer to enthalpy as a change has seemed unnecessarily bothersome by some users of thermodynamic data, and so they have devised an alternate, but acceptable arbitrary way of thinking about enthalpy. In this scheme the enthalpy of a pure element in its most stable form at 298 K and 1 atm is arbitrarily assigned an enthalpy of zero. This is not unlike assigning a point on the Virginia coast as sea level: elevation 0. The Pacific Ocean sea level is several feet higher (at Panama) and that tides move sea level regularly and substantially, but since elevations are a relative measure, any arbitrary zero will still provide the sought changes in elevation. So it is with enthalpy in the present case. Absolute enthalpies might be compared to actual elevations which would be measured from the center of the Earth: very difficult to do and a waste of effort since only changes in elevation are needed.

Entropy

Unlike enthalpy, absolute entropy values are known. As described in the chapter on the Third Law, the entropy of a pure crystalline material is zero at absolute zero. Given measured values of heat capacity from near absolute zero to any temperature of interest, makes possible the computation of absolute entropy by integrating Equation (2.3). Table 5.2 shows selected values of entropy (absolute values) determined by such integration.

Entropy changes may also be computed for changes in temperature (sensible entropy), transformations (entropy of transformation), and for reactions (entropy of reaction). Sensible entropy changes are computed from the definition of entropy in Equation (2.3).

$$dS \equiv \left(\frac{dq}{T} \right)_{Rev} \quad (5.7)$$

In the case of sensible heats this is the same as Equation (3.2)

$$dS_{Sen} = \int_0^T \frac{Cp dT}{T} \quad (5.8)$$

The entropy of transformation at constant pressure is the enthalpy of transformation divided by the equilibrium temperature of the transformation. The condition of constant pressure assures that the enthalpy change is the heat of the transformation and the equilibrium temperature conforms to the required reversible conditions. For example the entropy of transformation for the fusion of Cu is

$$Cu_s = Cu_l \quad (5.9)$$

is

$$\Delta S_{Tran,Cu,fusion}^{\circ} = \frac{\Delta H_{fusion,Cu}^{\circ}}{T_{fusion,Cu}} = \frac{3,170 cal}{1356 K} = 2.338 \frac{cal}{K} \quad (5.10)$$

These entropies of transformation are so easily computed from the enthalpy and temperature of transformation, they are often not tabulated. It is presumed a person trained in thermodynamics would know this fundamental concept.

The same idea may be used to compute the reaction entropy change if the reaction if the heat of reaction is known when the reaction is at equilibrium. This is an unusual condition and the heat of reaction at equilibrium is rarely easily found. Consequently, entropies of reaction are typically computed by totaling the entropies of the reaction products and subtracting the sum of the reaction reactants. For example, the entropy change for the reaction



is

$$\Delta S_{R,298K}^{\circ} = 2S_{CO,298K}^{\circ} - S_{CO_2,298K}^{\circ} - S_{C_{graphite},298K}^{\circ} \quad (5.12)$$

Heats of reaction at 298 K from heats of formation

The last important piece of information needed to compute the enthalpy and entropy for any reaction at 298 K is how to use heat of formation data to find the heat of any reaction.

Currently the only data presented is for heats of formation, which by definition are reactions from the elements in their most stable form. These may be used to determine the heat of any reaction. Consider the reaction given in Equation (5.11). One may reform the CO_2 into its elements in their most stable form and then reform the elements into the products. The sum of all of the deforming and reforming reactions equals the enthalpy change of the reaction.

Each of the deforming steps is the negative of the deformed compound and the reforming enthalpies are the heats of formation. Figure 5.2 shows the deforming of CO_2 and the forming of 2CO from these deforming products and the original mole of C. The sum of these enthalpy changes is the heat of reaction

$$\Delta H_{R,298K}^{\circ} = 2\Delta H_{\text{form},\text{CO},298K}^{\circ} - \Delta H_{\text{form},\text{CO}_2,298K}^{\circ} \quad (5.13)$$

This is more simply remembered as the sum of the heats of formation of the products (the final state) minus the sum of the enthalpies of the reactants (initial state). It is of the same form as Equation (5.12), except the heat of formation of graphite is not written since it is zero being an element in its most stable form.

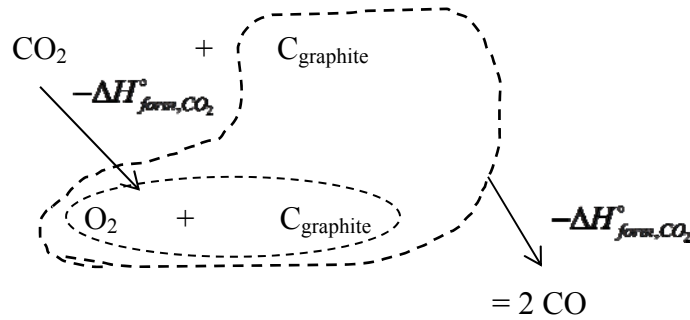

Figure 5.2 Schematic showing the computation of the heat of reaction from the heats of formation

Calculation schematic for enthalpies and entropies at T other than 298 K

The previous computations for enthalpy and entropy of reaction were at the same temperature as the data: namely 298 K. In this section, the method of computing reaction enthalpies and reaction entropies at other temperatures using heat capacities will be developed. It will be assumed that the only data available consists of heats of formation at 298 K, entropies at 298 K, transformation data at the temperatures of transformation, and heat capacity data, which is fitted to the following function of temperature

$$C_p = a + bT + cT^{-2} \quad (5.14)$$

The method will be developed for enthalpies. It is then easily extended to entropy computations.

The method used is based on the concept of state function. The enthalpy changes from reactants to products will necessarily equal the change along any path. The methods presented earlier cannot be used for the direct path because there is no heat of formation data available at temperature T. Therefore, the reactants will be taken along an indirect path along which all the enthalpy changes can be computed that ends with the products in their final state. Then sum of all the enthalpy changes along the path will be the enthalpy change for the desired direct path. This is illustrated in Figure 5.3 below.

The Enthalpy of reaction at 500 K cannot be computed directly but if the CO₂ and the C are cooled to 298 K and reacted there where the heats of reaction are available, the CO product can be heated to 500 K ending where it is intended to be in the original reaction. Since the sum of the enthalpy changes are the same by any path, the Heat of reaction at 500 K may be computed using

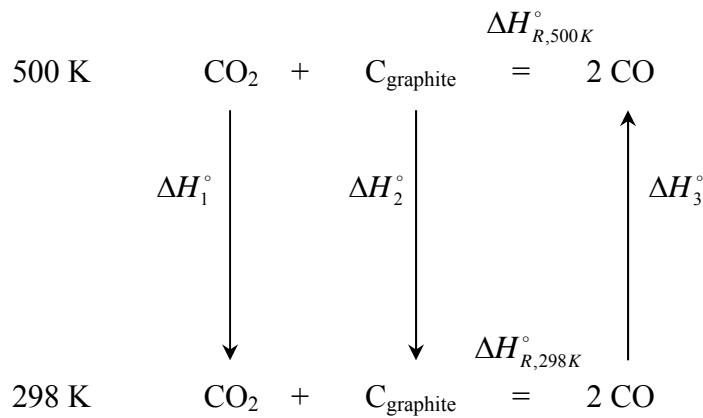

Figure 5.3 The computation schematic for the enthalpy of reaction at 500 K from heat of formation data at 298 K.

$$\Delta H_{R,500K}^\circ = \Delta H_{R,298K}^\circ + \sum_{i=1}^3 \Delta H_i^\circ \quad (5.15)$$

The three enthalpies in the summation are each sensible heats that may be computed as follows:

$$\sum_{i=1}^3 \Delta H_i^\circ = \int_{500K}^{298K} C_{p_{CO_2}} dT + \int_{500K}^{298K} C_{p_C} dT + 2 \int_{298K}^{500K} C_{p_{CO}} dT \quad (5.16)$$

Equation (5.15) is then simplified to

$$\Delta H_{R,500K}^{\circ} = \Delta H_{R,298K}^{\circ} + \int_{298K}^{500K} \Delta C_p dT \quad (5.17)$$

where $\Delta C_p = 2C_{p_{CO}} - C_{p_{CO_2}} - C_{p_C}$

The term ΔC_p is simply the heat capacity of products (final state) minus the heat capacity of the reactants (initial state). One can reduce the computation effort by combining the coefficients in Equation (5.14), When integrated Equation (5.17) becomes

$$\sum_{i=1}^3 \Delta H_i^{\circ} = \Delta a(500 - 298) + \frac{\Delta b}{2}(500^2 - 298^2) - \Delta c \left(\frac{1}{500} - \frac{1}{298} \right) \quad (5.18)$$

where $\Delta a = 2a_{CO} - a_{CO_2} - a_C$; $\Delta b = 2b_{CO} - b_{CO_2} - b_C$; $\Delta c = 2c_{CO} - c_{CO_2} - c_C$

The schematic presented in Figure 5.3 was easy to construct because as the reactants and products in the particular example do not go any phase transformations between 298 and 500 K. In case where phase transformations occur, they must be incorporated into the path constructed. Unfortunately, use of the greatly simplified Equation (5.15) is no longer mathematically valid. An example of such a reaction is the oxidation of Pb at 1000 K. Pb melts at 600 K. The calculation schematic for the oxidation is shown in Figure 5.4. The first sensible heat for Pb now consists of two sensible heat I_l and I_s and one heat of transformation I_t .

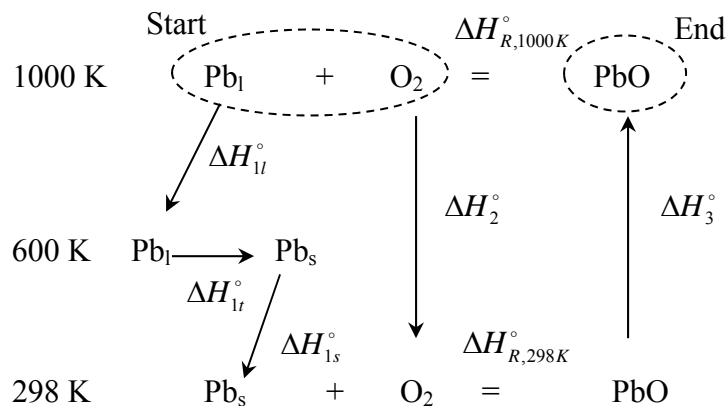

Figure 5.4 The computation schematic for the enthalpy of Pb oxidation at 1000 K from heat of formation data at 298 K.

Some students find useful thinking of the computation schematic as a river-crossing task. The reactants are at the start on one bank and the products are at the end location on the other bank. The reactants are all moved to the bridge where they react to the products, which are then moved to the final ending location. The known heat of formation is the bridge. As one

moves reactants or products downstream (lower T) or upstream (higher T) the phase transformation steps must be included in the accounting of changes in enthalpy.

Entropy of reaction

The same calculation schematic followed to find the enthalpy of a reaction may be used to find the entropy of the reaction. Entropies are typically reported at 298 K. The reactants may be moved using sensible and transformation entropy changes, as needed, to reach 298 K where they may be reacted to form products that are then raised to the final temperature using the required sensible and transformation entropies needed to move the products to the ending temperature. Figures 5.3 written for entropy computations is shown in Figure 5.5 and Equation (5.17) becomes

$$\Delta S_{R,500K}^{\circ} = \Delta S_{R,298K}^{\circ} + \int_{298K}^{500K} \frac{\Delta Cp}{T} dT \tag{5.19}$$

if there are no phase transformations between 298 K and 500 K. If there are phase transformations, then the phase transformations must be taken into account. The calculation schematic for entropy of reaction at 1000 K corresponding to Figure 5.4 is shown in Figure 5.6. There are four sensible entropy changes (1,1s,2, and 3); one transformation (1t) and one entropy of reaction at 298 K. The sum of these entropy changes equals the entropy of reaction at 1000 K.

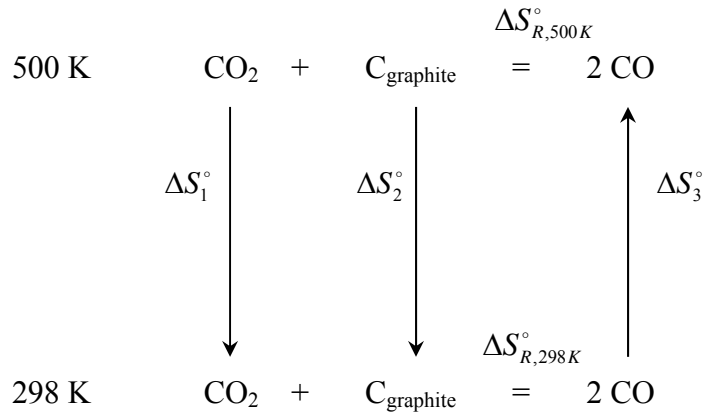

Figure 5.5 The computation schematic for the entropy of reaction at 500 K from entropy data at 298 K.

Gibbs energies of reaction

The Gibb’s energy of reaction can be computed at a given temperature from the corresponding enthalpy and entropy changes for the reaction as shown in Equation (5.1) at the beginning of this chapter.

$$\Delta G_{R,T}^{\circ} = \Delta H_{R,T}^{\circ} - T \Delta S_{R,T}^{\circ} \tag{5.1}$$

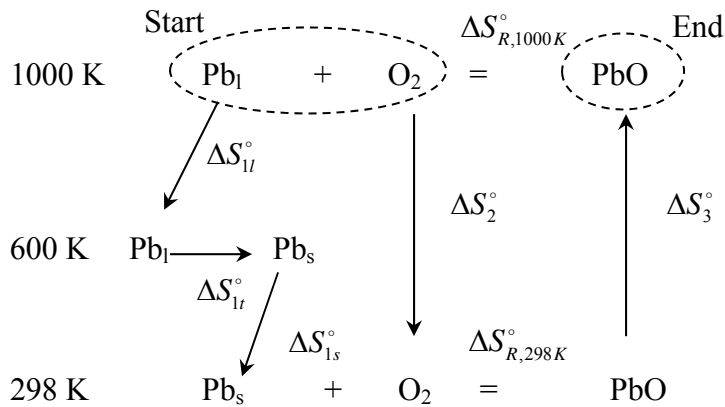

Figure 5.6 The computation schematic for the enthalpy of Pb oxidation at 1000 K from heat of formation data at 298 K.

The superscript “o” denotes that the reactants and products are all in their standard state, which for solids and liquids are the pure materials and gases are at 1 atm (actually at fugacity 1 but that will be discussed later). According to the criterion of equilibrium for a system at constant T and P, a reaction in which the reactants and products are in equilibrium will have a standard Gibbs energy change of zero, while spontaneous reactions will be negative; positive values indicate a propensity for the reaction to go from right to left. As a practical matter, the computation of Gibbs energy changes for reactions is usually greatly simplified by fitting the results of the above described lengthy procedures for computing $\Delta H_{R,T}^{\circ}$ and $\Delta S_{R,T}^{\circ}$ to simpler functions of temperature: usually linear function suffice. Table 5.3 shows the linear fit equations of the standard Gibbs energy for selected reactions.

Table 5.3 Standard Gibbs energy linear data fit for selected reactions

Reaction	$\Delta G_{R,T}^{\circ} = A + BT$		T Range (K)
	A (cal/gmole)	B (cal/K)	
$C_{\text{graphite}} + 0.5 O_{2(g)} = CO_{(g)}$	-26,700	-20.95	298-2273
$C_{\text{graphite}} + O_{2(g)} = CO_2$	-94,200	-0.20	298-2273
$3Fe_{\alpha} + 2 O_{2(g)} = Fe_3O_4$	-260,770	74.75	298-833
$H_{2(g)} + 0.5 O_{2(g)} = H_2O_{(g)}$	-58,900	13.10	298-1973
$2 Al_{(l)} + 1.5 O_{2(g)} = Al_2O_{3(s)}$	-402,300	77.83	968-1973

From the Making Shaping and Treating of Steel 10th ed.

Students are cautioned not to conclude that by the Method of Coefficients that A is $\Delta H_{R,T}^{\circ}$ and that B is $-\Delta S_{R,T}^{\circ}$. To make such a conclusion is to assume that both $\Delta H_{R,T}^{\circ}$ and $\Delta S_{R,T}^{\circ}$ are

functions of temperature. Yet, so long as ΔC_p is not zero they are functions of temperature and A and B are approximations of $\Delta H_{R,T}^\circ$ and $\Delta S_{R,T}^\circ$.

Uses of the calculation Schematic

In addition to the uses described above, there are many other uses for the calculation schematic. One of great practical significance is to use it to determine the heat balance for an industrial process with several reactant input and several product output streams each one with its unique temperature. The schematic can be used to describe the overall progress from input to exit by entering all of the sensible, transformation, and reaction enthalpies needed to progress from inputs to outputs. The sum of all the enthalpies is the overall heat balance for the reaction process. Such a problem is beyond the scope of an introductory course on chemical thermodynamics but not beyond the student’s capability to perform after mastering the current subject matter.

Adiabatic flame temperature: AFT

A common example for the use of the calculation schematic is the calculation of the adiabatic flame temperature AFT. The AFT is the temperature reached by the products of combustion if all the heat of combustion is used to heat the products. Since no heat escapes from the system, the term adiabatic is used to describe the computation. The first step in constructing the calculation schematic for the burning of natural gas at room temperature with pure oxygen is shown in Figure 5.7a and consists of placing the known information on the schematic with temperature as the vertical direction and reaction progress in the horizontal direction. A path is then constructed along which all enthalpy changes can be computed. If heats of formation data are available at 298 K, then the reactants can be taken to products at 298 K since the heat of that reaction can be calculated from the heats of formation. The CO₂ and H₂O products are then raised to the final state, which is the unknown but to be calculated AFT. The completed calculation schematic is shown in Figure 5.7b and consists of one heat of reaction and two sensible heats. The sum of these three enthalpies must equal zero to maintain the condition of adiabatic. The only unknown is the final temperature of the reaction products, the AFT, as shown in Equation (5.20).

$$\sum_{i=1}^3 \Delta H_i = \Delta H_{R,298K}^\circ + \int_{298}^{AFT} (Cp_{CO_2} + 2Cp_{H_2O})dT = 0 \tag{5.20}$$

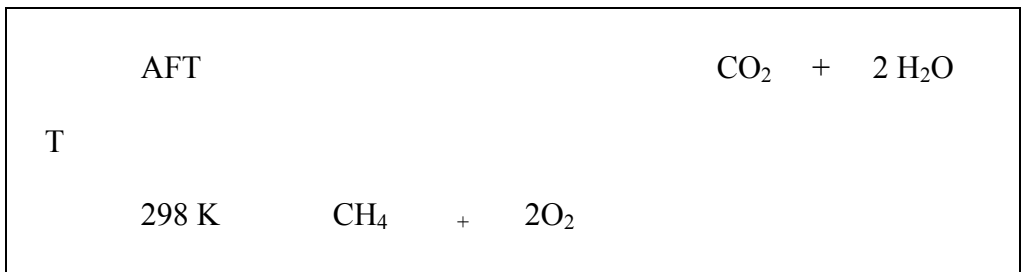

(a)

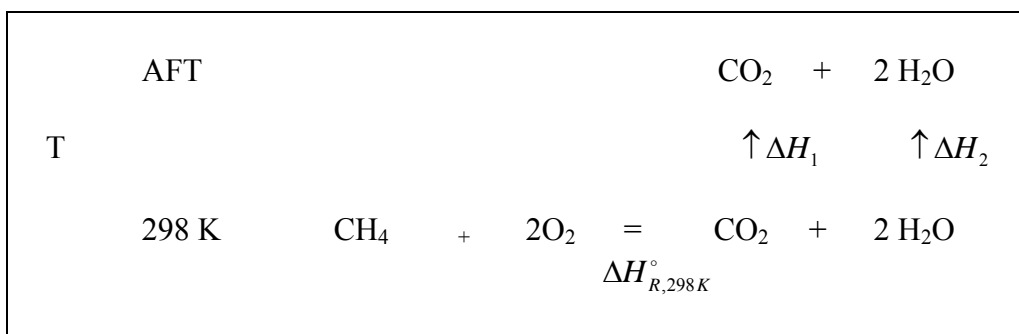

(b)

Figure 5.7 Calculation schematic for determining the AFT for the combustion of natural gas with pure oxygen both at 298 K: a) known information, b) computational path

Transformation reaction values at T other than the equilibrium T

It can be useful to know the heat of transformation at temperatures other than the equilibrium temperature. For example, pure solid NaCl melts to form pure liquid NaCl at 1074 K, but it also becomes a liquid when it is dissolved in water at room temperature. The heat of fusion at room temperature is required to change the NaCl from solid to liquid in a water solution. There is also the matter of solution heat, which is covered in a later chapter. The calculation schematic can be used to find the heat of fusion for NaCl at temperatures other than 1074 K as shown in Figure 5.8. The solid NaCl at 298 K is heated to 1074 K and then fused to liquid, which is then cooled to 298 K. The sum of the three enthalpies associated with these three changes total the enthalpy of fusion at 298 K.

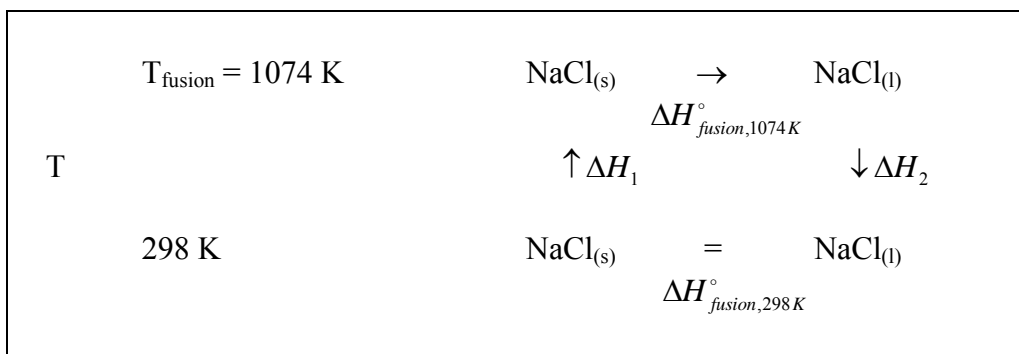

Databases

There are many thermochemical databases but two of the most commonly used are the JANAF and ThermoCalc[®].

JANAF The acronym name is formed from the first letters of the Joint Army Navy Air Force who commissioned this database in the 1960's. With the widespread availability of high speed computers, it became possible to mathematically process data that could be arrived at by more than one computational route or source and a make it internally consistent. This internal consistency feature of JANAF Thermochemical Tables combined with its careful attention to detail that made it a major achievement. It has remained a key source of thermochemical data and is available by hard copy or sometimes digitally for free.

The database uses the enthalpy and Gibbs energy of formation schema combined with, of course, absolute entropy. These values are tabulated from 0 K in 100 K increments, plus 298 K. Table 5.3 shows some selected datasheets from the JANAF Thermochemical Tables.

ThermoCalc[®]

ThermoCalc[®] is a digital thermochemical computational application with user-selectable databases some of which are highly specialized for specific systems such as those for nickel-based alloy steels. A common database for use in chemical reactions involving pure substances is the SSUB3 database. The database for each substance contains the following data:

the coefficients for temperature dependent heat capacity function is used to compute entropies from absolute zero using Equation (5.8). Enthalpies are calculated using Equation (5.2) the *Arbitrary-defined system for Enthalpy* in which the entropy of a pure element in its most stable form is zero at 298 K. Enthalpies of formation and phase changes are included in the database so as to allow the computation of so-called absolute enthalpies based on the *Arbitrary-defined system for Enthalpy*. Once the entropy and enthalpy for all reactants and products involved in a reaction, one may easily find the change in entropy, enthalpy, or Gibbs energy of the reaction by computing the difference in the values for the products (final state) minus the reactants (initial state) for the desired quantity. Table 5.4 shows selected data sheet output from ThermoCalc[®].

Table 5.3 Selected JANAF Thermochemical Tables

Table 5.4 Selected ThermoCalc[®] output.

Chapter 6

Simple System - One component systems

Basic Concepts

- Phase diagrams
- Clausius-Clapeyron Equation
- The effect of P on H and S

Before trying to understand the behavior of a system composed of multiple components, one should have a clear understanding of how one-component systems behave. Temperature and pressure are the state variables of greatest interest that determine the state of a component.

Phase diagrams

Figure 6.1 shows a one component phase diagram for H₂O. The Internet has many such diagrams for H₂O that may be found by search. One such diagram that is of particular interest because it extends to extreme pressures that might be of great interest to geologists is shown in Figure 6.2. Most students are surprised to learn that H₂O has many different solid phases. Some exist well above 400 °C at tremendously high pressure (>100 kbar, ~1.5 million psi).

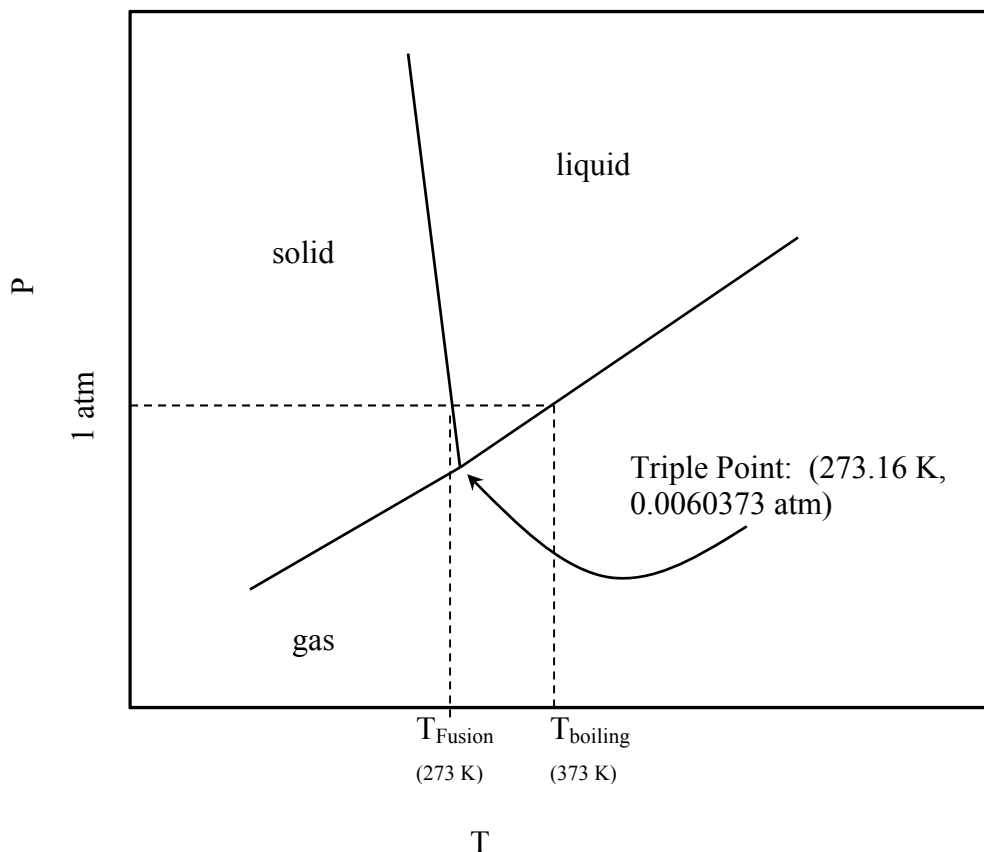

Figure 6.1 Phase diagram for H₂O

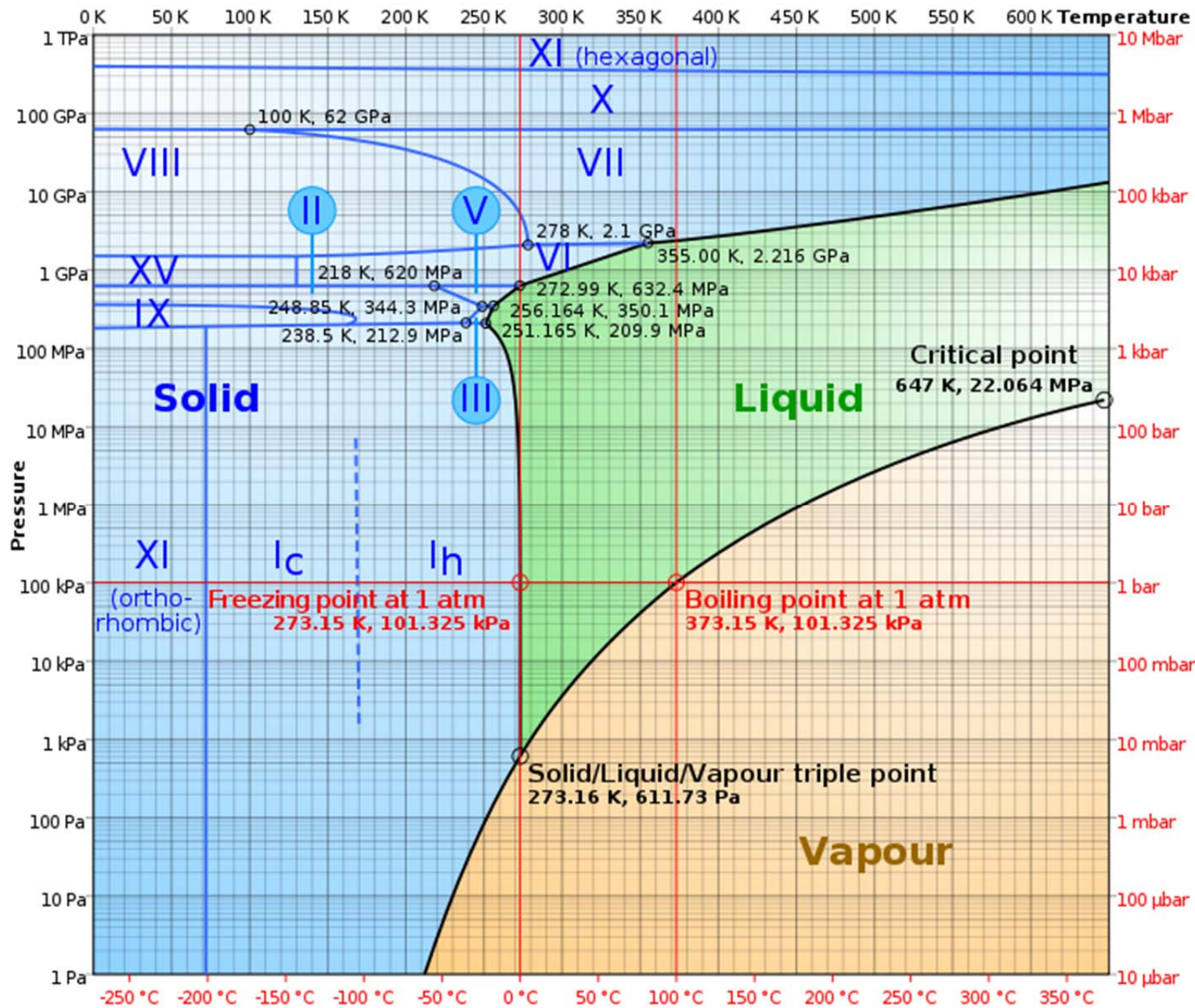

Figure 6.2 The H₂O phase diagram at extreme pressures showing several solid forms of ice. (http://en.wikipedia.org/wiki/Triple_point)

When heat is added to a component, its temperature rises in proportion to its heat capacity. This relationship continues as shown in Figure 6.3 until a phase transition is encountered. At the phase transformation temperature, the temperature remains constant until the transformation is completed. The temperature then continues to increase in proportion to the heat capacity of the new phase present. Equation (1.19) defines the heat capacity C_p as the slope of the lines for each phase in Figure 6.3. The heat capacity of ice is only $0.504 \text{ cal} \cdot \text{g}^{-1} \cdot \text{K}^{-1}$; whereas water is $1.00 \text{ cal} \cdot \text{g}^{-1} \cdot \text{K}^{-1}$. Steam at the boiling point has a heat capacity of $0.497 \text{ cal} \cdot \text{g}^{-1} \cdot \text{K}^{-1}$. Therefore, the slope of the line for water is essentially twice that for the ice-steam line. The large amount of enthalpy required to vaporize a substance is much larger than the heat for fusion. The lines for each phase have some slope since the heat capacity is a function of temperature. This is easy to observe for the steam. The student should note that only changes in enthalpy are needed and that the absolute value of enthalpy is inconsequential.

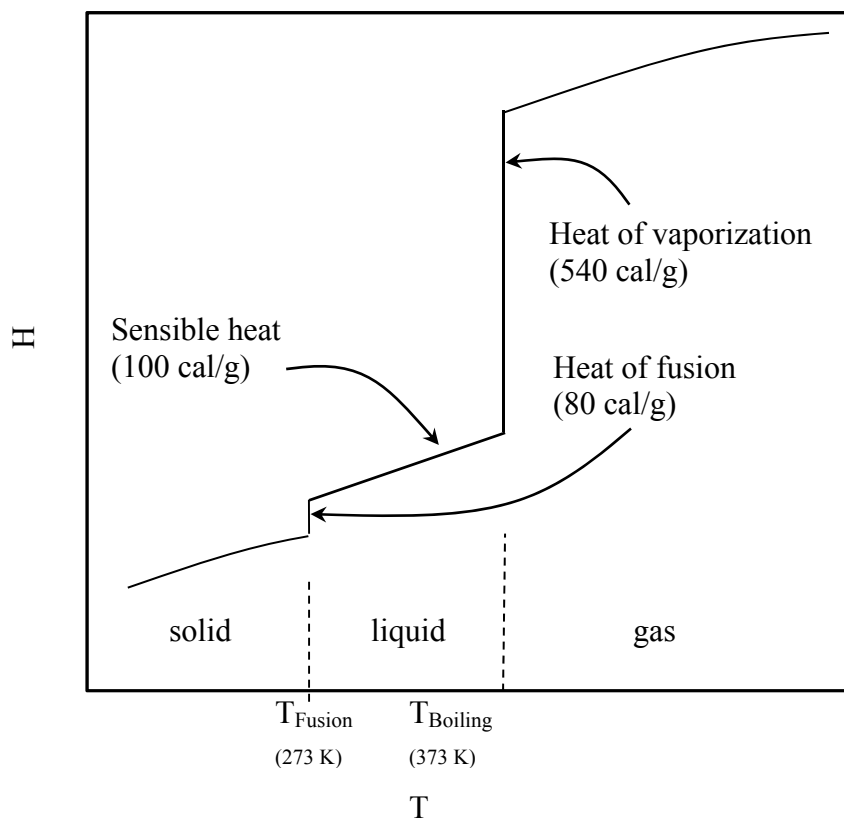

Figure 6.3 Enthalpy diagram at constant pressure for one component system with phase transformations

Clausius-Clapeyron Equation

The slopes of the lines defining the boundary between any two phases on Figure 6.1 are mathematically related to known or measurable properties of the component. These mathematical relationships arise from the concept of equilibrium. For a system at constant temperature and pressure, the criterion of equilibrium is that the two phases must have the same Gibbs energy. If they did not, the one of lower Gibbs energy would be favored and the other phase would transform into the phase of lower Gibbs energy. There are two distinct kinds of equilibria between phases: 1) those between two condensed phases such as $\alpha = \beta$ and $s = l$, and 2) those between a condensed phase and a gas phase such as $s = g$ or $l = g$. Each case can be described mathematically.

Two Condensed Phases

At equilibrium between two condensed phases, a solid and a liquid for example, one may write for the line along which they are in equilibrium

$$G_s = G_l \quad (6.1)$$

This provides the starting point for the derivation of the Clausius Equation. Equation (6.1) may be written in differential terms

$$dG_s = dG_l \quad (6.2)$$

Substituting the Fundamental Equation, Equation (4.7), for a closed system and rearranging gives

$$\frac{dP}{dT} = \frac{(S_l - S_s)}{(V_l - V_s)} = \frac{\Delta S}{\Delta V} \quad (6.3)$$

At equilibrium $\Delta S = \frac{\Delta H}{T}$, which when substituted into Equation (6.3) gives the Clausius Equation

$$\frac{dP}{d \ln(T)} = \frac{\Delta H}{\Delta V} \quad (6.4)$$

When using the Clausius Equation it makes no difference which direction the reaction is written so long as the values for ΔH and ΔV are consistent. The ratio of $\Delta H/\Delta V$ remains the same for any quantity under consideration: i.e. one gram, one mole, etc.

Example 6.1: Find the slope of the line between ice and water on a plot of pressure vs. T at 0°C .

Solution:

Assume the direct of the phase transformation is $s \rightarrow l$.

The volume change is

$$\Delta V = V_l - V_s = \frac{1}{\rho_l} - \frac{1}{\rho_s} = \frac{1}{1\text{g}\cdot\text{cm}^{-3}} - \frac{1}{0.9\text{g}\cdot\text{cm}^{-3}} = -0.11\text{cm}^3\cdot\text{g}^{-1}$$

The enthalpy change is

$$\Delta H = 80\text{cal}\cdot\text{g}^{-1}$$

$$\frac{dP}{dT} = \frac{\Delta H}{T\Delta V} = \frac{80\text{cal}}{-0.11\text{cm}^3\cdot 273\text{K}} \cdot \frac{R}{R} = \frac{80\text{cal}}{-0.11\text{cm}^3\cdot 273\text{K}} \cdot \frac{82.05\text{cm}^3\cdot\text{atm}}{1.987\text{cal}} = -110 \frac{\text{atm}}{\text{K}} \quad (6.5)$$

Therefore, increasing the pressure on a water-ice system at 273 K will lower the melting point by 1 K to 272 K.

Example 6.2 Find the slope of the line between ice and water on a plot of pressure vs. $\ln(T)$.

Solution:

$$\frac{dP}{d\ln(T)} = \frac{80\text{cal}}{-0.11\text{cm}^3} \cdot \frac{R}{R} = \frac{80\text{cal}}{-0.11\text{cm}^3} \cdot \frac{82.05\text{cm}^3\cdot\text{atm}}{1.987\text{cal}} = -30,032\text{atm} \quad (6.6)$$

Example 6.3: Find the equilibrium ice-water pressure for a decrease in the fusion temperature of 13 K to 260 K. Assume the volume change and enthalpy are constant and the same value as at 273 K and 1 atm.

Solution:

$$\int_{1\text{atm}}^P dP = \frac{80\text{cal}}{-0.11\text{cm}^3} \int_{273\text{K}}^{260\text{K}} d\ln(T) \quad (6.7)$$

$$P = 1\text{atm} - \frac{80\text{cal}}{0.11\text{cm}^3} \ln\left(\frac{260}{273}\right) \frac{R}{R} = 1,466\text{atm} \quad (6.8)$$

One condensed phase and one gas phase

At equilibrium between a condensed phase and a gas phase, a liquid and a gas for example, one may as before write for the equilibrium condition

$$G_l = G_g \quad (6.9)$$

Using the same approach as for the two condensed phases, Equation (6.4) also results. However, the volume change may be replaced by the volume of the gas phase since it is so much larger than the volume of the condensed phase.

$$\frac{dP}{dT/T} = \frac{\Delta H}{V_g - V_l} \approx \frac{\Delta H}{RT/P} \quad (6.10)$$

Rearranging gives the Clausius-Clapeyron Equation.

$$\frac{d \ln(P)}{d(1/T)} = -\frac{\Delta H_{vap}}{R} \quad (6.11)$$

Example 6.4: The boiling point of liquid Cu is 2836 K. The vapor pressure of Cu at its melting point is 5.98×10^{-7} atm. Calculate the enthalpy of vaporization of liquid Cu from this information. Assume the enthalpy of vaporization is constant.

Solution:

Integrating

$$\frac{d \ln(P)}{d(1/T)} = -\frac{\Delta H_{vap}}{R}$$

$$\ln\left(\frac{P_2}{P_1}\right) = -\frac{\Delta H_{vap}}{R} \left[\frac{1}{T_2} - \frac{1}{T_1} \right] \quad (6.12)$$

If the subscript “2” is used to denote the boiling point and “1” for the melting point data, then substitution and rearranging gives

$$\Delta H_{vap} = -\frac{R \ln\left(\frac{P_2}{P_1}\right)}{\left[\frac{1}{T_2} - \frac{1}{T_1}\right]} = -\frac{1.987 \text{ cal} \cdot \text{gmole}^{-1} \cdot \text{K}^{-1} \ln\left(\frac{1 \text{ atm}}{5.98 \times 10^{-7} \text{ atm}}\right)}{\left[\frac{1}{2836 \text{ K}} - \frac{1}{1356 \text{ K}}\right]} = 73,984 \text{ cal} \cdot \text{gmole}^{-1}$$

This compares to a value of 73,522 cal/gmole at the mid temperature of 2096 K by Hultgren.

Example 6.5: What is the temperature inside a pressure cooker containing boiling water at one atm above ambient pressure of 1 atm? The heat of vaporization of water is 540 cal/g.

Solution:

From Equation (6.12)

$$\ln\left(\frac{2 \text{ atm}}{1 \text{ atm}}\right) = -\frac{\Delta H_{vap}}{R} \left[\frac{1}{T_2} - \frac{1}{T_1} \right] = \frac{540 \text{ cal} / \text{g} \cdot 18 \text{ g} / \text{gmole}}{1.987 \frac{\text{cal}}{\text{gmole} \cdot \text{K}}} \left[\frac{1}{T_2} - \frac{1}{373 \text{ K}} \right] \quad (6.13)$$

$T_2 = 393.8 \text{ K}$ or 20.8 Kelvin hotter than the boiling point at 1 atm.

The effect of P on H and S

Small changes in pressure have negligible effects on the values of enthalpy and entropy; however when the pressures are extreme such as in the production of synthetic diamonds or thermochemical computations at geologic depths the variation of enthalpy and entropy must be considered.

The effect of pressure on enthalpy may be found at constant T by dividing fundamental Equation (4.5) by dP to obtain

$$\left(\frac{dH}{dP}\right)_T = T\left(\frac{dS}{dP}\right)_T + V \quad (6.14)$$

Substituting Maxwell Equation (4.20) gives

$$\left(\frac{dH}{dP}\right)_T = T\left(\frac{dV}{dT}\right)_P + V \quad (6.15)$$

The change in V with T at constant P is the product of the thermal coefficient of expansion, α , and the molar volume. Also shown is the definition of the compression coefficient β .

$$\alpha \equiv \frac{1}{V}\left(\frac{\partial V}{\partial T}\right)_P \quad \beta \equiv -\frac{1}{V}\left(\frac{\partial V}{\partial P}\right)_T \quad (6.16)$$

Substitution and Rearrangement gives the final result.

$$\left(\frac{dH}{dP}\right)_T = (1 + \alpha T)V \quad (6.17)$$

Example 6.6 What is the change in the enthalpy for graphite at 298 K as it is compressed from 1 atm to 1,000 atm? Assume the thermal coefficient of expansion for graphite and density are constant values of 2.265 g/cm^3 and $28.5 \times 10^{-6} \text{ K}^{-1}$.

Solution:

From Equation (6.17)

$$H_{298 \text{ K}, 1,000 \text{ atm}} - H_{298 \text{ K}, 1 \text{ atm}} = (1 + \alpha T)V \int_{1 \text{ atm}}^{1,000 \text{ atm}} dP \quad (6.18)$$

$$\Delta H = (1 + 28.5 \times 10^{-6} \text{ K}^{-1} \cdot 298 \text{ K}) \frac{12 \text{ g / gmole}}{2.265 \text{ g / cm}^3} (1,000 - 1) \text{ atm} \cdot \frac{R}{R} = 129 \text{ cal / gmole}$$

Maxwell Equation (4.20) gives directly the change in entropy with pressure.

$$\left(\frac{dS}{dP}\right)_T = \left(\frac{dV}{dT}\right)_P = \alpha V \quad (6.19)$$

Example 6.7 What is the change in the entropy for graphite at 298 K as it is compressed from 1 atm to 1,000 atm? Assume the thermal coefficient of expansion for graphite and density are constant values of 2.265 g/cm^3 and $28.5 \times 10^{-6} \text{ K}^{-1}$.

Solution:

From Equation (6.19)

$$S_{298K,10,000\text{atm}} - S_{298K,1\text{atm}} = \alpha V \int_{1\text{atm}}^{1,000\text{atm}} dP \quad (6.20)$$

$$\Delta H = 28.5 \times 10^{-6} \text{ K}^{-1} (1,000 - 1) \text{ atm} \frac{12 \text{ g / gmole}}{2.265 \text{ g / cm}^3} \cdot \frac{R}{R} = 3.65 \times 10^{-3} \frac{\text{cal}}{\text{K} \cdot \text{gmole}}$$

Chapter 7

Multiple component systems

Basic Concepts

- Definition of activity
- Ideal solutions
- The Big Six Equations
- Equilibrium Constants
- Reaction Extent
- Ellingham Diagrams

This chapter describes how the Gibbs energy change may be used to compute the conditions of chemical equilibrium. Students have used the equilibrium constant or solubility constant in chemistry courses before taking thermochemistry. In this chapter the relationship between the equilibrium constant and the Gibbs energy change will be derived.

Definition of activity

The chemical activity of a species i is defined implicitly at temperature T as

$$\mu_i = \mu_i^\circ + RT \ln a_i \quad (7.1)$$

where μ_i is the chemical potential defined earlier in Equation (4.33). The superscript " $^\circ$ " denotes what is called the reference state. Usually the reference state for a solid or liquid is the species i in its pure state at temperature T . For a gas it is usually the species i behaving as an ideal gas at 1 atm pressure. In a later chapter the use of other reference states is described; however, it should be clear that when a species is in its reference state it has an activity of unity by definition.

Ideal solutions

The relationship between activity and mole fraction of a component in solution is found by writing Equation (7.1) in differential form and substituting the Fundamental Equation (4.7) for $d\mu_i$

$$VdP_i = RTd \ln a_i \quad (7.2)$$

If one assumes ideal gas behavior by substituting the Ideal Gas Law and integrating from the pure component to the component in a solution, the following relationship is obtained.

$$RT \int_{P_i^{\text{pure } i}}^i \frac{dP_i}{P_i} = RT_i \int_{P_i^{\text{pure } i}}^i d \ln a \quad (7.3)$$

$$a_i = \frac{P_i}{P_i^\circ} \quad (7.4)$$

This equation is often purported to be the definition of activity, but it is a consequence of the definition.

Figure 7.1 shows several ways a partial pressure of a species i in equilibrium with the solution may vary with the mole fraction of the species in solution, x_i . An ideal solution will have a partial pressure that is directly proportional to its mole fraction. That is, if half the atoms in solution are species i , then the partial pressure of i , P_i , will be one half of the pure species' vapor pressure, P_i° . Therefore, for an ideal solution

$$P_i = x_i P_i^\circ \quad (7.5)$$

Substituting Equation (7.5) into Equation (7.4) gives

$$a_i^{Ideal} = x_i \quad (7.6)$$

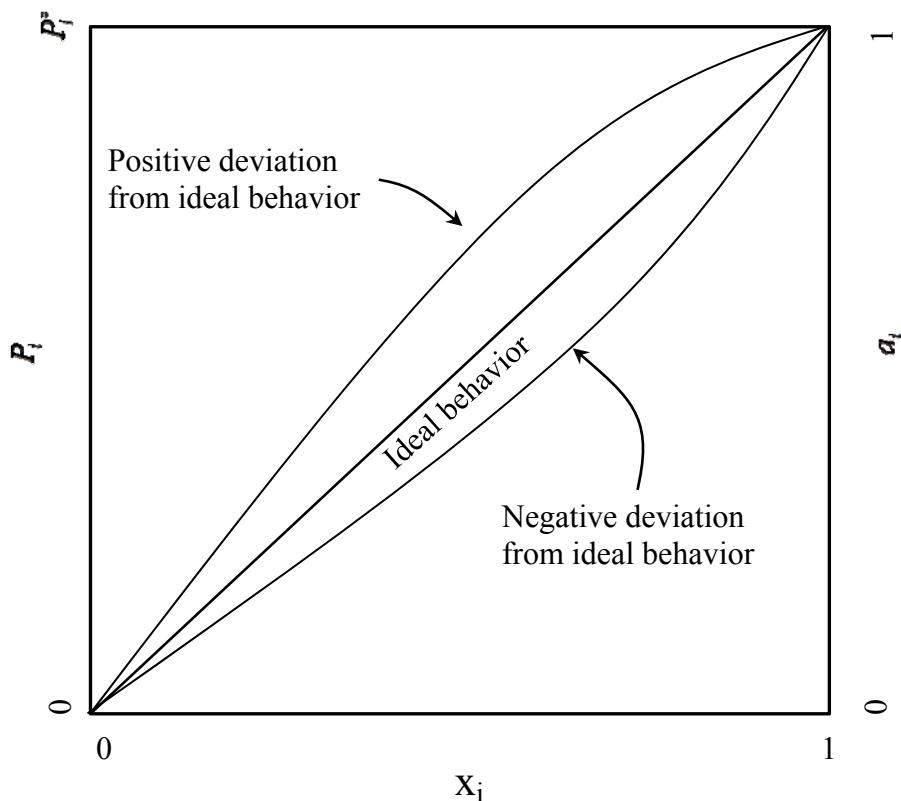

Figure 7.1 The partial pressure of species i as a function of mole fraction of i for a) an ideal solution, a solution that departs positively from ideal behavior, and c) a solution that departs negatively from ideal behavior.

This is to say that the chemical activity of a species equals the mole fraction in an ideal solution where the pure component is the reference state. For non-ideal solutions an activity coefficient defined as

$$\gamma_i \equiv \frac{a_i}{x_i} \quad (7.7)$$

is used to relate the activity to the mole fraction.

$$a_i = \gamma_i x_i \quad (7.8)$$

In summary, for an solution that exhibits

negative departure from ideal behavior :	$\gamma_i < 1$
ideal behavior :	$\gamma_i = 1$
positive departure from ideal behavior :	$\gamma_i > 1$

The right scale of Figure 7.1 is determined by Equation (7.4). The activity coefficient and other properties of solutions are treated in much greater detail in the chapter on solution thermodynamics.

The Big Six Equations

When working with species involved in chemical reactions, one needs to be able to account for the change in Gibb's energy in solutions as in the case for solids or liquids or for changes in pressure as in the case for gases. Equation (4.7) provides a way to determine this for a gas at constant T.

$$dG = VdP \quad (7.9)$$

For an ideal gas the Ideal Gas Law gives

$$dG = RTd \ln P \quad (7.10)$$

which on integration from any pressure P to the standard pressure of 1 atm gives

$$\mu_i = \mu_i^\circ + RT \ln \frac{P_i}{P_i^\circ} \quad (7.11)$$

where P_i° is 1 atm

$$\mu_i = \mu_i^\circ + RT \ln p_i \quad (7.12)$$

The same form is used for a real gas but a new term fugacity, f_i , is introduced.

$$\mu_i = \mu_i^\circ + RT \ln f_i \quad (7.13)$$

Fugacity has the same value as pressure if the gas is ideal. If a gas is not ideal, fugacity is the value that gives the correct Gibbs energy. Equation (7.13) may be written in terms of pressure by introducing the fugacity coefficient, $\gamma_i \equiv f_i/p_i$

$$\mu_i = \mu_i^\circ + RT \ln \gamma_i p_i \quad (7.14)$$

Figure 7.2 shows values of the ratio of fugacity to pressure at various reduced pressures and temperatures.

The collection of equations for ideal and real gases and solutions plus two addition equations for aqueous solutions gives the so-called Big Six Equations:

$$\text{Ideal Gas:} \quad \mu_i = \mu_i^\circ + RT \ln p_i \quad (7.15)$$

$$\text{Real Gas:} \quad \mu_i = \mu_i^\circ + RT \ln f_i \quad f_i \equiv \gamma_i p_i \quad (7.16)$$

$$\text{Ideal Solution:} \quad \mu_i = \mu_i^\circ + RT \ln x_i \quad (7.17)$$

$$\text{Real Solution:} \quad \mu_i = \mu_i^\circ + RT \ln a_i \quad a_i \equiv \gamma_i x_i \quad (7.18)$$

$$\text{Ideal Aqueous Solution:} \quad \mu_i = \mu_i^\circ + RT \ln [i] \quad (7.19)$$

$$\text{Real Aqueous Solution:} \quad \mu_i = \mu_i^\circ + RT \ln [a_i] \quad [a_i] \equiv \gamma_i [i] \quad (7.20)$$

where $[i]$ = the molar concentration of component i in aqueous solution
 $[a_i]$ = the activity of species i in aqueous solution.

Whenever a component is in its reference state, $\mu_i = \mu_i^\circ$ so the logarithmic term is zero by definition. Therefore, $p_i, f_i, x_i, a_i, [i], [a_i]$ are unity by definition when the component is in its reference state. As for Equation (7.11), these values are in the denominators of each logarithmic term; for example ideal gas with a reference state of 1 atm

$$\mu_i = \mu_i^\circ + RT \ln \left(\frac{p_i}{p_i^\circ} \right) = \mu_i^\circ + RT \ln \left(\frac{p_i}{1 \text{ atm}} \right) \quad (7.21)$$

Since all these terms are unity, they are not written; however, these unwritten terms do ensure that there are no units in the logarithmic terms. The Big Six Equations are used to relate the Gibb's energy change for a reaction to the equilibrium constant as shown next.

Equilibrium Constants

Consider the reaction



The Gibbs Energy change for the reaction is

$$\Delta G = c\mu_C + e\mu_E - a\mu_A - b\mu_B \quad (7.23)$$

Substituting from the Big Six Equations at a constant temperature for each Gibbs energy per mole gives

$$\Delta G = \Delta G^\circ + RT \ln(Q) \quad (7.24)$$

where
$$\Delta G^\circ = c\mu_C^\circ + e\mu_E^\circ - a\mu_A^\circ - b\mu_B^\circ \quad (7.25)$$

$$Q = \frac{a_C^c [a_E]^e}{f_A^a a_B^b} \quad (7.26)$$

The term Q is a measure of prevailing conditions. At equilibrium $\Delta G = 0$ and so

$$\Delta G^\circ = -RT \ln(K_{EQ}) \quad (7.27)$$

where
$$K_{EQ} = \left[\frac{a_C^c [a_E]^e}{f_A^a a_B^b} \right]_{\text{Equilibrium}} \quad (7.28)$$

If the gas A and the solutions behave ideally, the equilibrium constant may be written

$$K_{EQ} = \left[\frac{x_C^c [E]^e}{p_A^a x_B^b} \right]_{\text{Equilibrium}} \quad (7.29)$$

Reaction Extent

An interesting and important problem often encountered in equilibrium calculations is the problem of finding the extent of reaction required to reach equilibrium, given non-equilibrium starting conditions. For example, consider the reaction of nitrogen and hydrogen to produce ammonia gas at a total pressure of 7 atm.



If one chooses some arbitrary starting amounts of each reactant and product, the problem is then to determine how much of each reactant and product is present at equilibrium. The first column in Table 7.1 shows some arbitrarily chosen initial moles of each component. The next step in solving for the equilibrium state is to assign a reaction extent variable. The variable could

represent the number of moles that react of any of the three constituents or it could be the mole formed of any of the three constituents. Any one of these six choices is a satisfactory choice to proceed; however, some choices are preferable so as to avoid the need for fractions.

In Table 7.1, the variable x has been used to represent the number of moles of H_2 that react to achieve equilibrium. That selection having been arbitrarily made, column three is then completed using the stoichiometric relationships for the reaction. The final moles are totaled and the partial pressures of each species then written in terms of the extent variable using Dalton's Law of Partial Pressures: $p_i = x_i P_T$.

Species	Initial moles	Final moles	partial pressure, $p_i = x_i P_T$
N_2	20	$20-3x$	$\frac{20-3x}{40-2x} P_T$
H_2	2	$2-x$	$\frac{2-x}{40-2x} P_T$
NH_3	18	$18+2x$	$\frac{18+2x}{40-2x} P_T$
Total	40	$40-2x$	P_T

The unknown reaction extent may then be computed by substituting the partial pressures into the equilibrium constant and solving for x as follows:

$$K_{EQ} = \frac{P_{NH_3}^2}{P_{N_2} P_{H_2}^3} = \frac{\left[\frac{18+2x}{40-2x} P_T \right]^2}{\left[\frac{20-3x}{40-2x} P_T \right] \left[\frac{2-x}{40-2x} P_T \right]^3} = 2.4 \quad (7.31)$$

Solving for x numerically (Excel Solver[®]) gives $x = -1.4343$. Substituting into Table 7.1 gives the results for the equilibrium condition shown in Table 7.2.

Species	Initial moles	Final moles	partial pressure, $p_i = x_i P_T$, atm
N_2	20	21.43	3.50
H_2	2	3.43	0.56
NH_3	18	15.13	2.47
Total	40	42.87	7.00

Ellingham Diagrams

The Ellingham Diagram is a plot of the standard Gibbs energy of formation versus T for compounds composed of one mole of a specified anion: O₂ in this explanation. Therefore, every reaction is based on one mole of O₂ gas for selected oxides. For example, where M represents a metal cation,

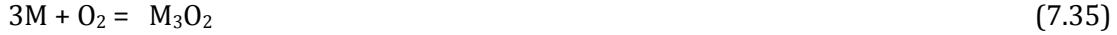

Using one mole of O₂ makes all reactions immediately comparable. For example if one wishes to compare the relative stability of Al₂O₃ and FeO, one reaction is subtracted from the other as follows:

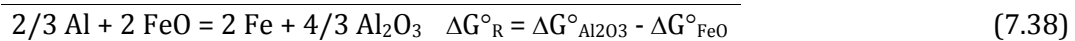
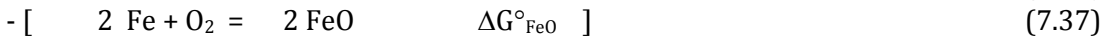
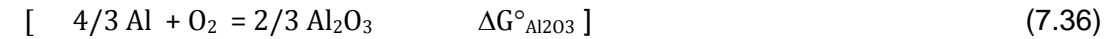

If $\Delta G^\circ_{\text{R}} < 0$ the reaction proceeds to the right
 $\Delta G^\circ_{\text{R}} > 0$ the reaction proceeds to the left
 $\Delta G^\circ_{\text{R}} = 0$ the reaction is at equilibrium

Which is to say that metal with the oxide having the smaller standard Gibbs energy of formation is oxidized while the other metal's oxide loses its oxygen being reduced to the metallic state. From a practical perspective, one may think as follows:

- Just as electrical current runs from high voltage to low voltage O₂ goes from high chemical potential to low chemical potential.
- Since O₂ "flows" (like current) from high to low potential, it goes to the lower oxides.
- Oxides at the bottom of the diagram are more stable than those at the top.
- Metals at the top of the diagram are *noble* and metals at the bottom of the diagram are *reactive*.

For the reactions



involving pure liquid or solid M and oxide (activities of unity), the standard Gibbs energy of formation is

$$\Delta G^\circ_{\text{R}} = -RT \ln 1/P_{\text{O}_2} = RT \ln P_{\text{O}_2} \quad (7.43)$$

All reactions are assumed to involve the pure metal and oxide, and gases other than O₂ as being at 1 atm. In keeping with Equation (7.15), the term RT ln P_{O₂} is related to the chemical potential of O₂ gas as follows:

$$\mu_{\text{O}_2} = \mu^\circ_{\text{O}_2} + RT \ln P_{\text{O}_2} / P^\circ_{\text{O}_2} \quad (7.44)$$

Of course for real gases, one would write the above expressions in terms of fugacities, but that is rarely necessary. Since $P_{O_2} = 1$ atm, the relative chemical potential is

$$\Delta\mu_{O_2} = \mu_{O_2} - \mu^{\circ}_{O_2} = RT \ln P_{O_2} \quad (7.45)$$

which is an alternative name for the vertical coordinate of the Ellingham diagram.

So, the vertical scale of the Ellingham Diagram is

$$\Delta G^{\circ}_R = RT \ln P_{O_2} = \Delta\mu_{O_2} \quad (7.46)$$

If one thinks of the vertical scale as the relative chemical potential, it makes it akin to O_2 *voltage* and O_2 goes to the compound having the lowest O_2 -potential just as electrical current flows to the lowest available potential. Voltage can be relative to anything – usually a stake at your home sets the ground as 0. The relative O_2 chemical potential is zero when the pressure of O_2 is 1 atm.

- The vertical scale is also O_2 relative potential (relative to O_2 gas at 1 atm).
- The basis of the relative state is of no consequence if we simply want to know where the O_2 reports at equilibrium.

Figure 7.2 Fugacity Coefficients

Nice Web sites

<http://mooni.fccj.org/~ethall/thermo/thermo.htm>
